

02101

02102

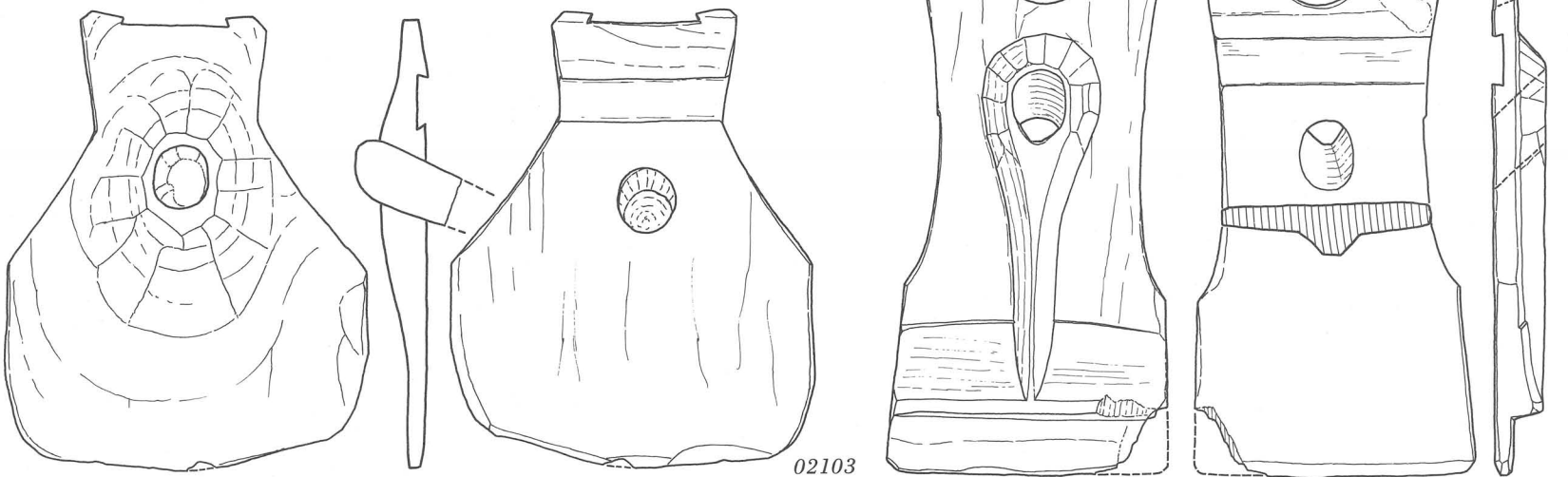

02103

02104

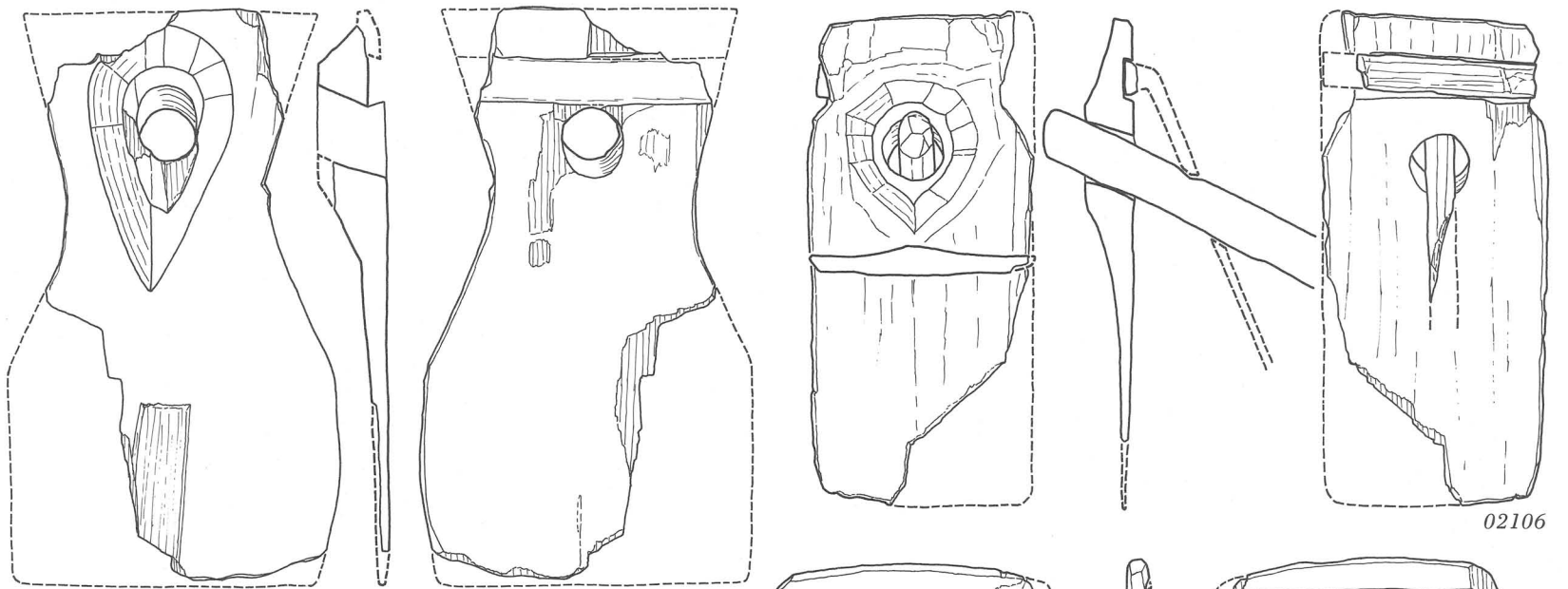

02105

02106

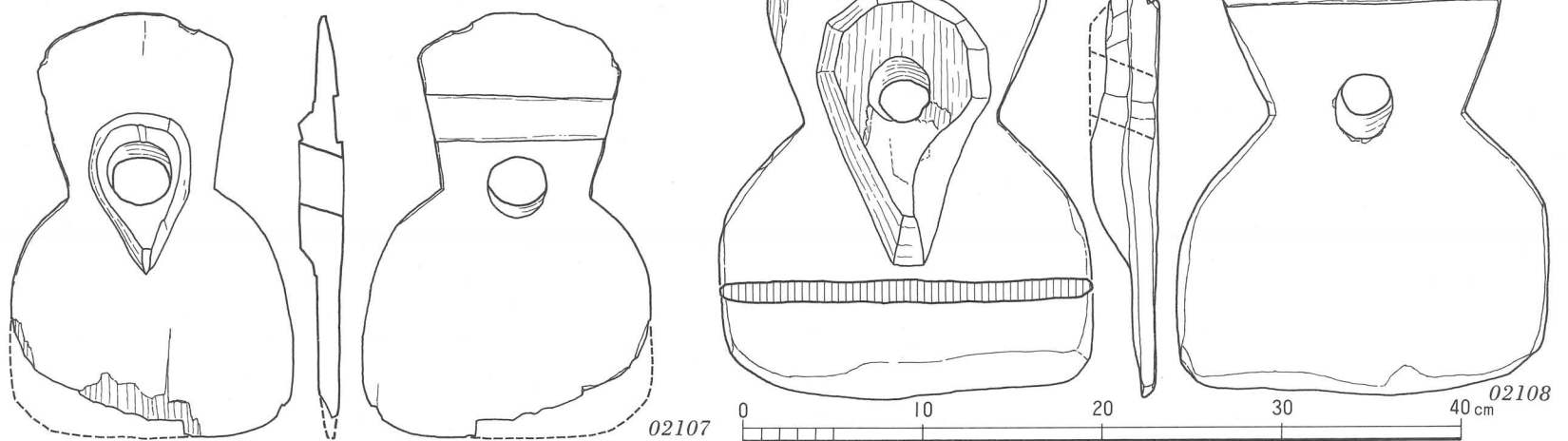

02107

02108

02101；大阪府西岩田， 02102；奈良県四分， 02103；奈良県城島(下田地区)， 02104；奈良県平城宮下層， 02105；滋賀県正伝寺南， 02106；大阪府美園， 02107；滋賀県湖西線， 02108；滋賀県入江内湖(行司町地区)



02201；滋賀県松原内湖，02202；奈良県平城宮下層，02203；兵庫県丁・柳ヶ瀬，02204・02206・02208；滋賀県入江内湖（行司町地区），02205；滋賀県旭，02207；滋賀県赤野井湾

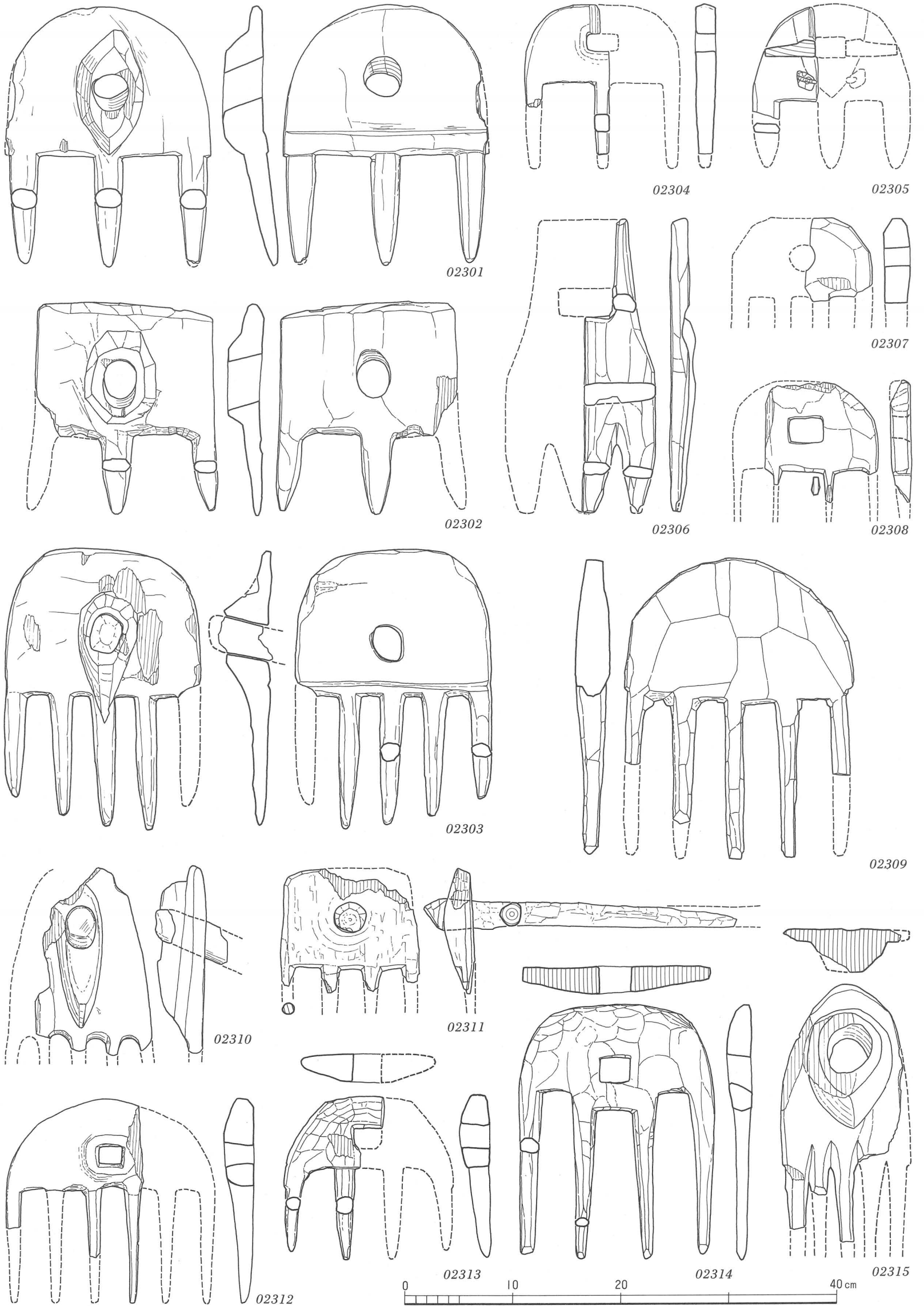

02301・02302；三重県納所，02303；大阪府池上，02304・02312・02314；大阪府瓜生堂，02305；兵庫県新方，02306；
 兵庫県播磨長越，02307；奈良県大福，02308・02311；大阪府鬼虎川，02309；滋賀県大中の湖南，02310；奈良県唐古，
 02313；京都府中久世，02315；滋賀県赤野井湾

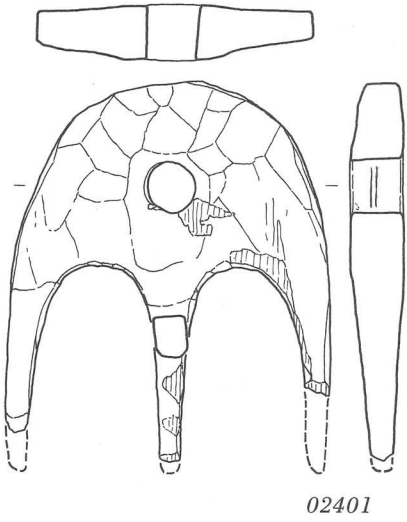

02401

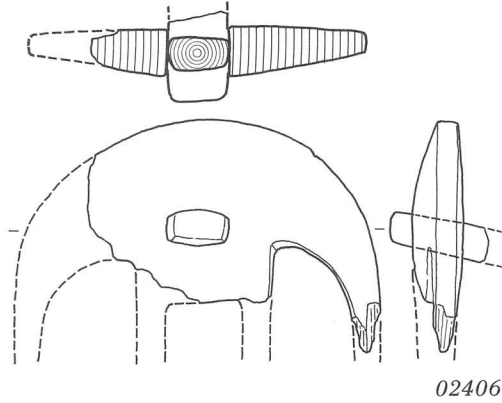

02406

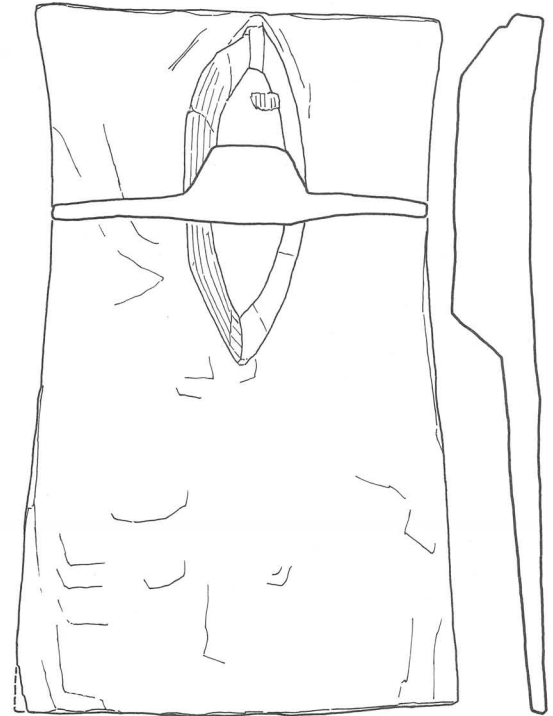

02412

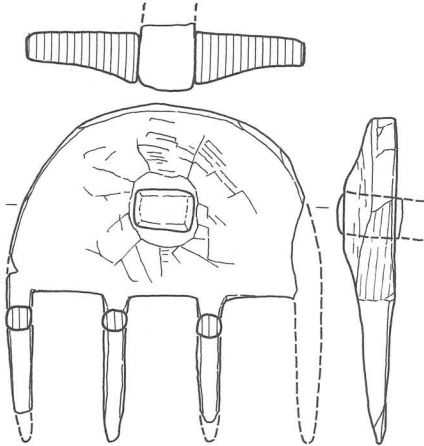

02402

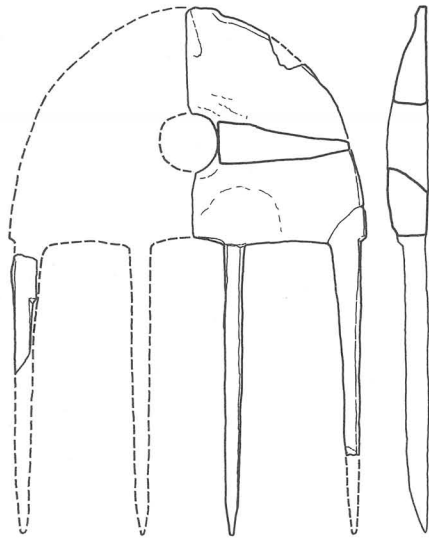

02407

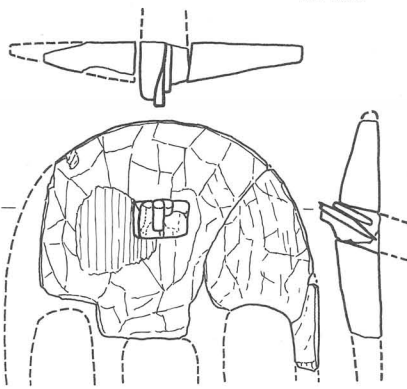

02403

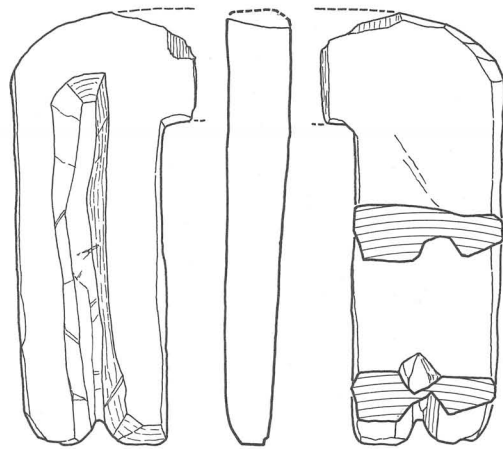

02410

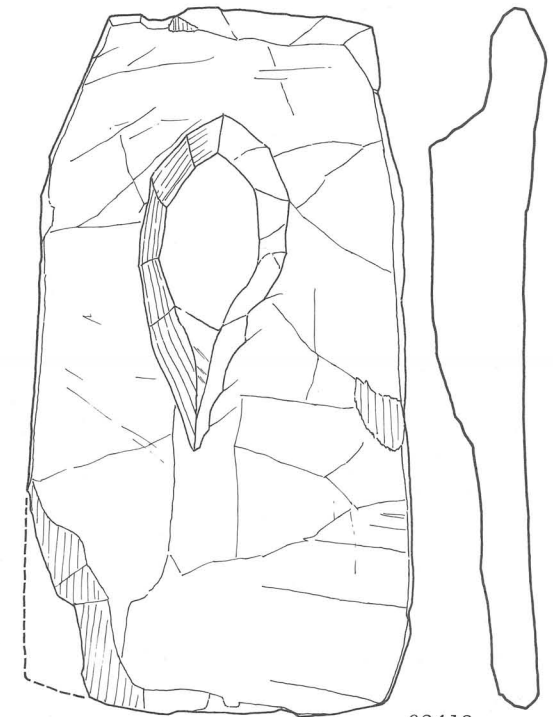

02413

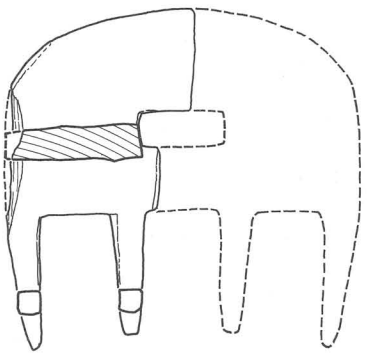

02404

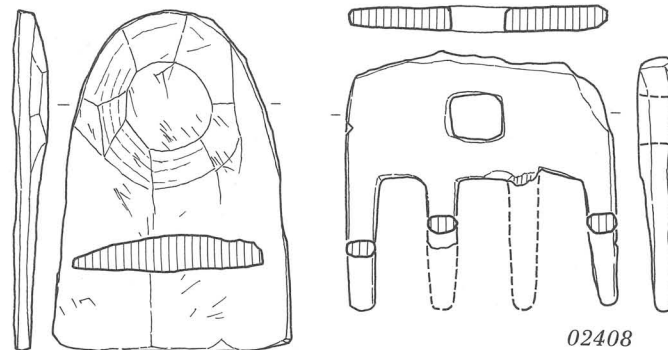

02411

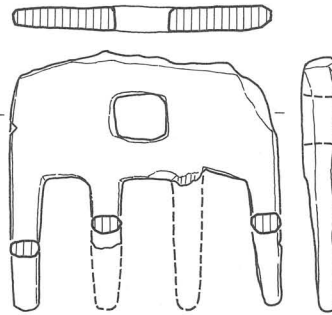

02408

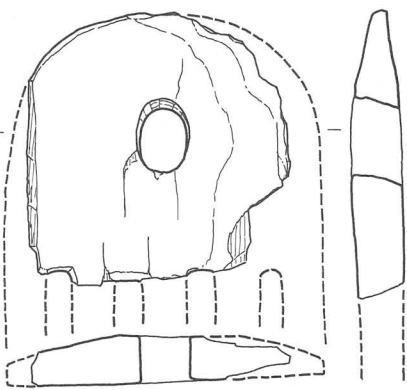

02405



02409

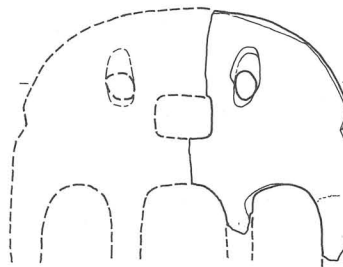

02414



02401・02407；大阪府瓜生堂，02402・02406・02408・02409；大阪府鬼虎川，02403；京都府中久世，02404；兵庫県玉津田中，02405；大阪府池上，02410；和歌山県田屋，02411；大阪府恩智，02412；大阪府高宮八丁，02413；大阪府四ツ池，02414；滋賀県入江内湖(行司町地区)

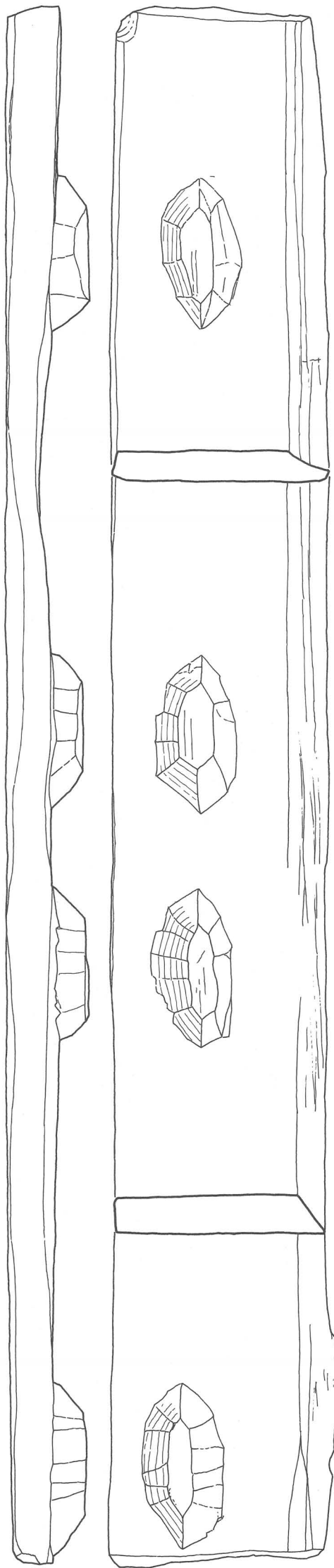

02501

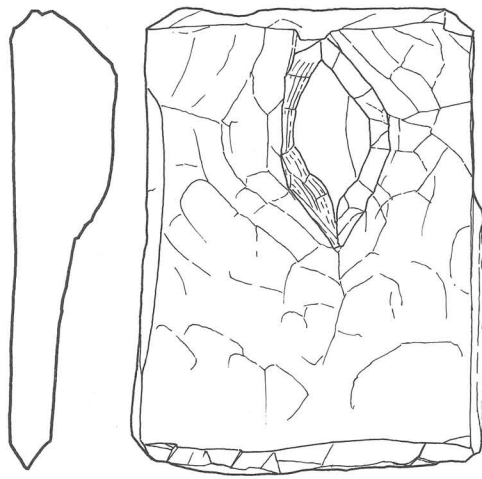

02504

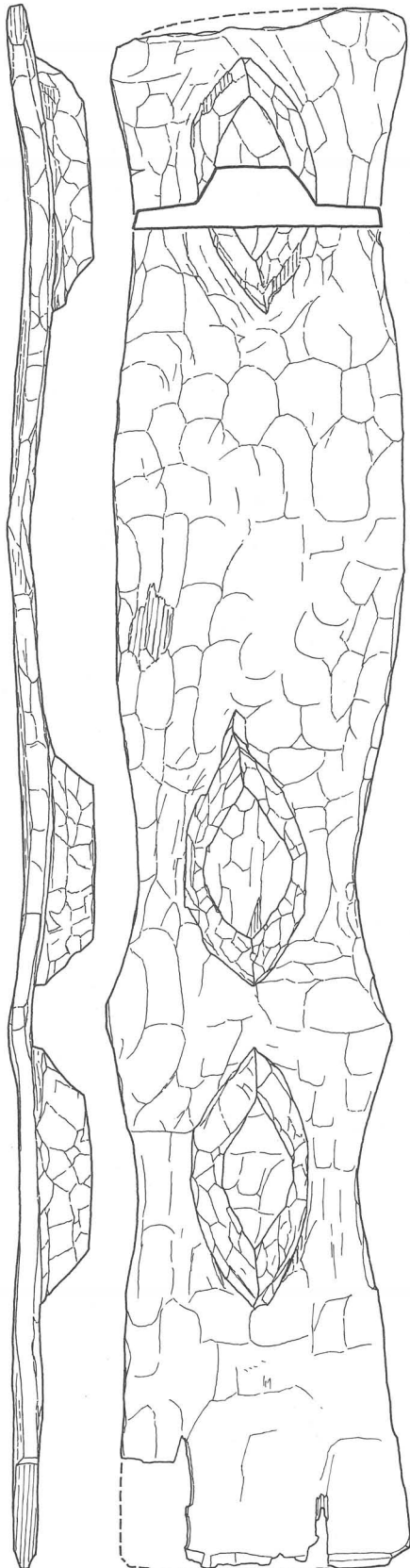

02502

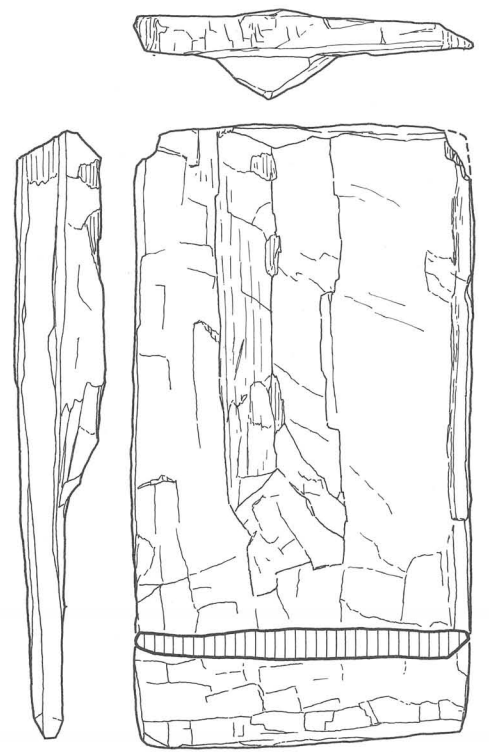

02505

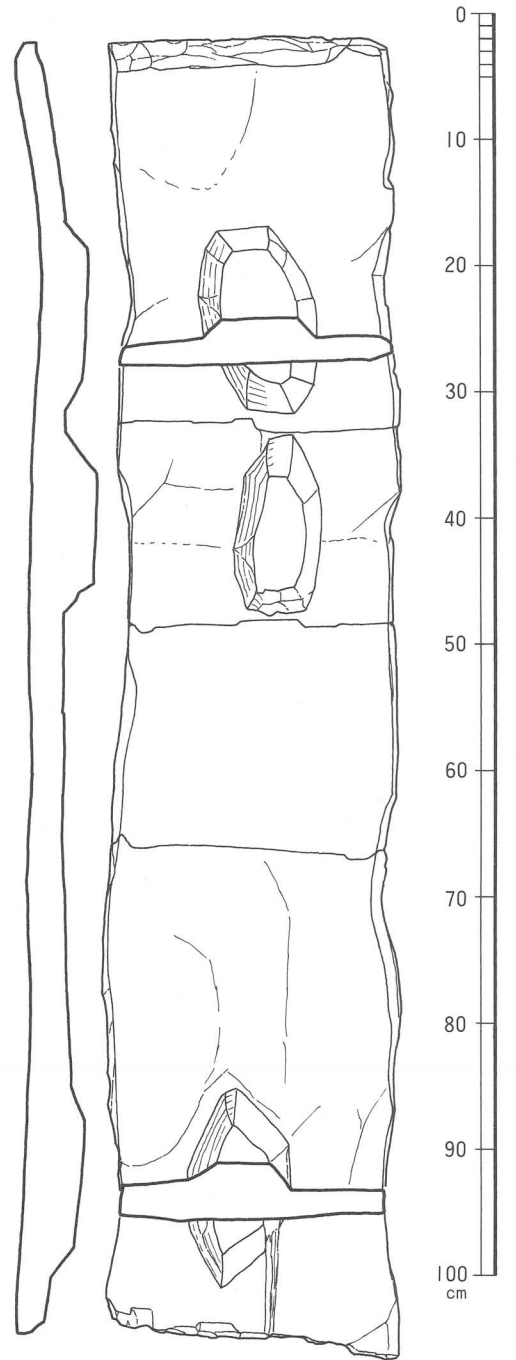

02503

02501；大阪府安満， 02502～02504；三重県納所， 02505；大阪府鬼虎川

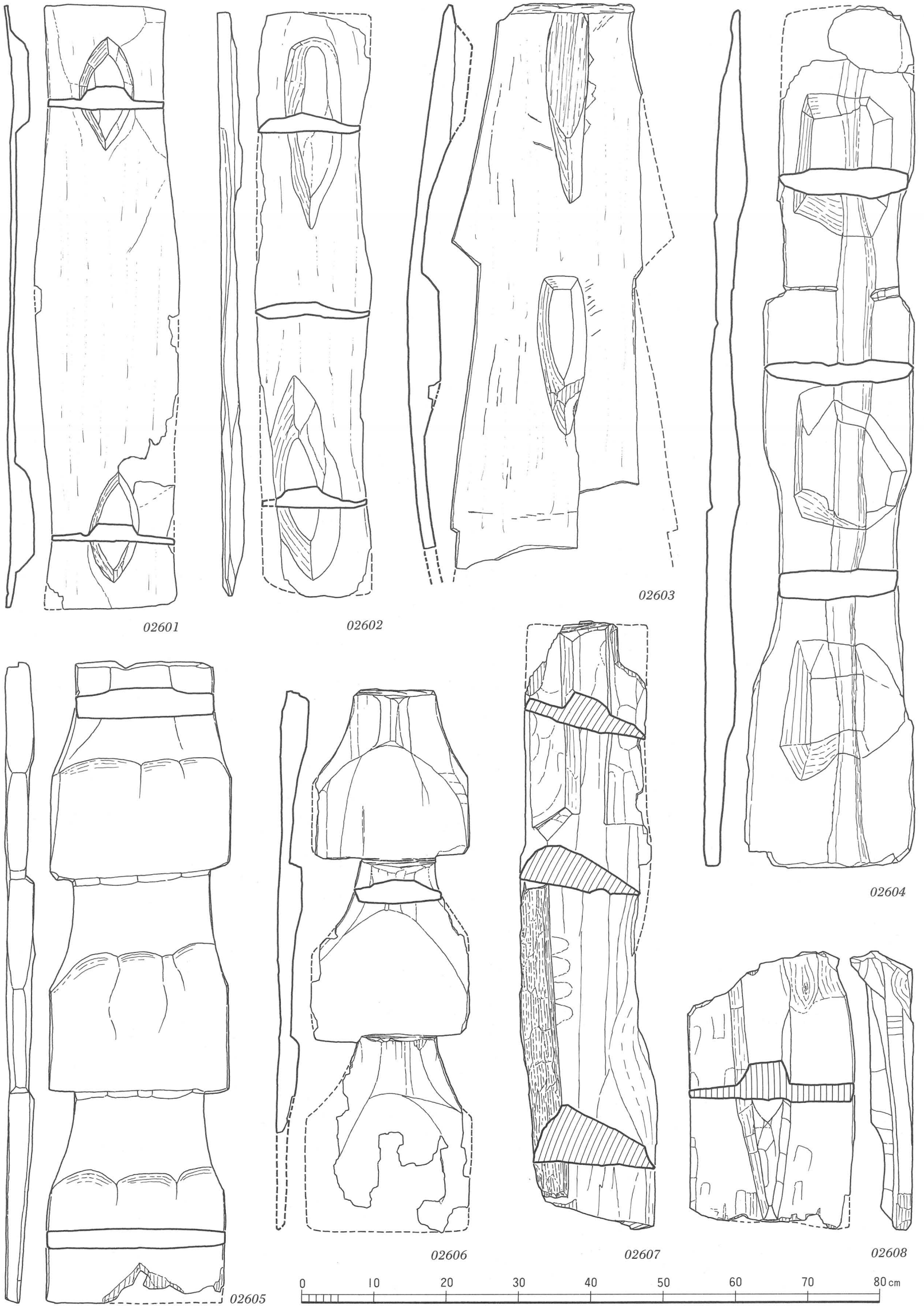

02601；滋賀県川崎， 02602；兵庫県東神吉， 02603・02605；奈良県唐古， 02604；大阪府亀井北， 02606；大阪府池上，
02607・02608；大阪府鬼虎川

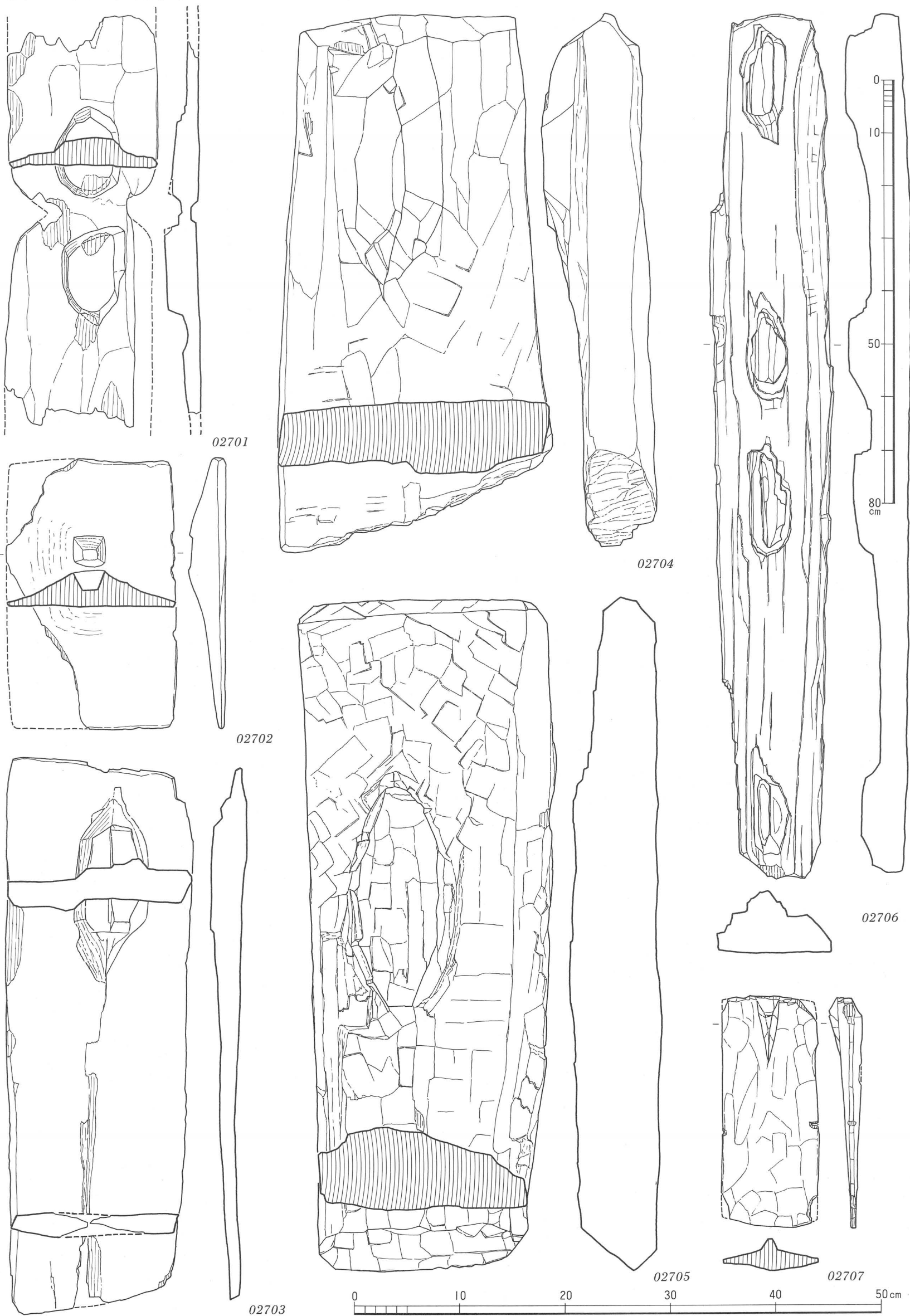

02701・02703；大阪府山賀， 02702・02704・02705・02707；大阪府鬼虎川， 02706；大阪府池上

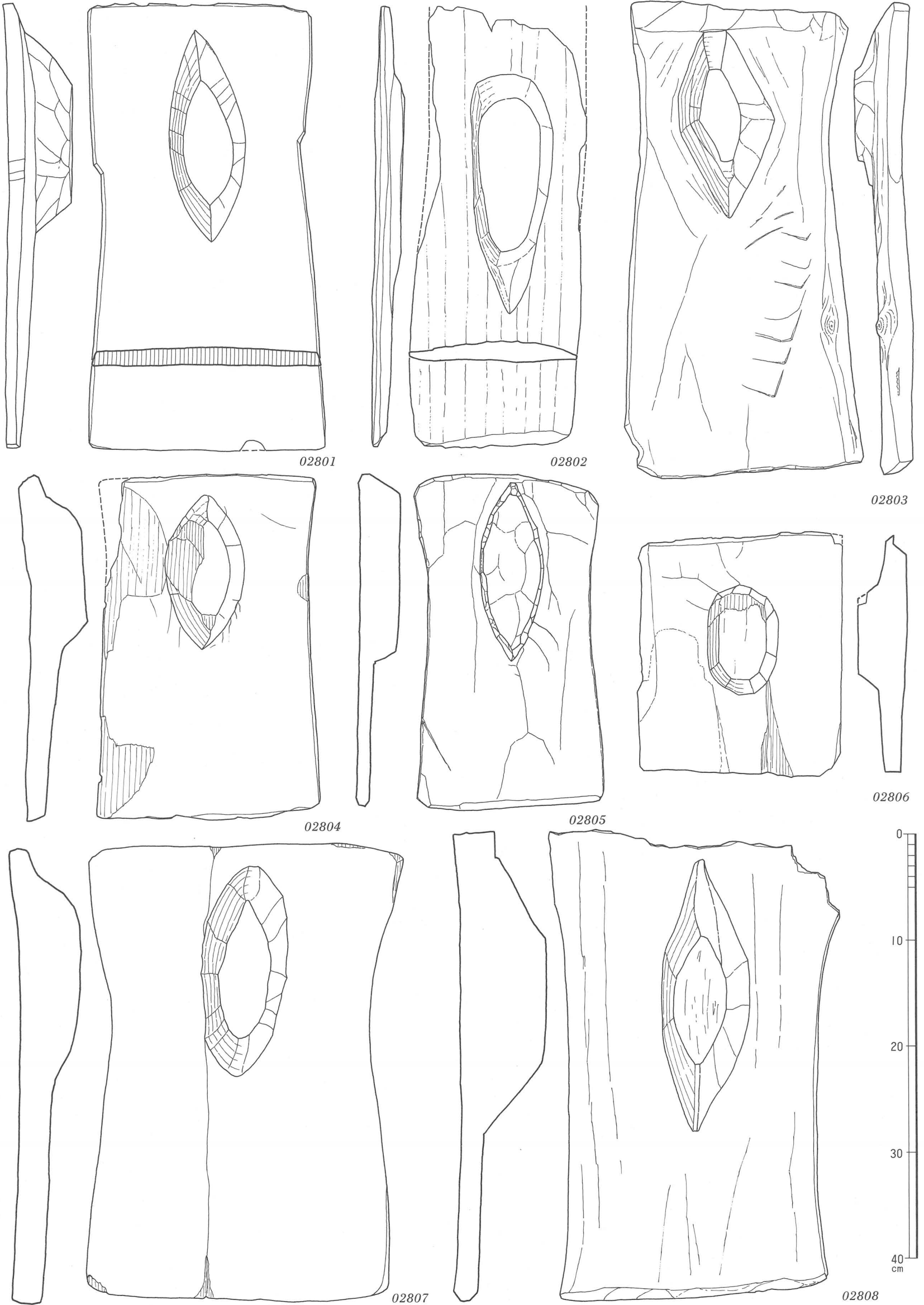

02801；大阪府安満， 02802；兵庫県東神吉， 02803・02808；奈良県唐古， 02804・02806；三重県納所， 02805；滋賀県大中の湖南， 02807；大阪府瓜破



02901；三重県納所，02902；大阪府東奈良，02903・02908；大阪府恩智，02904；大阪府亀井，02905・02907；大阪府池上，02906；京都府深草，02909；奈良県唐古・鍵

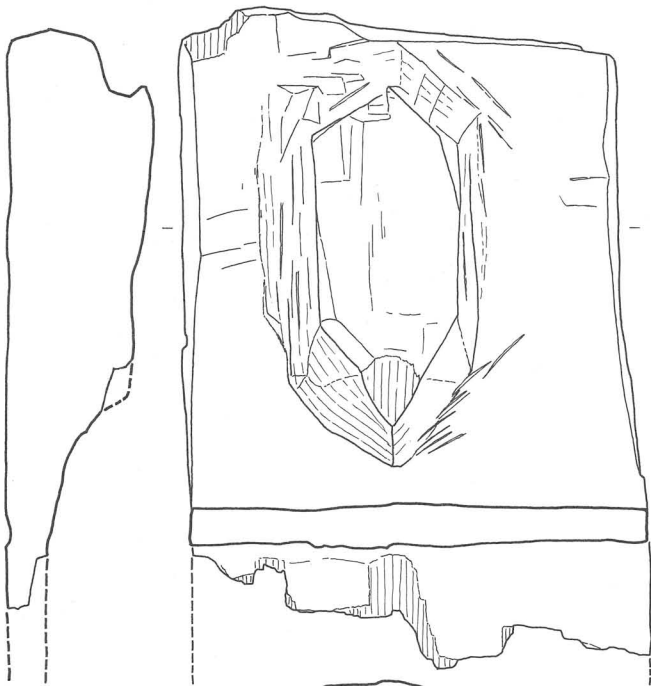

03001



03002

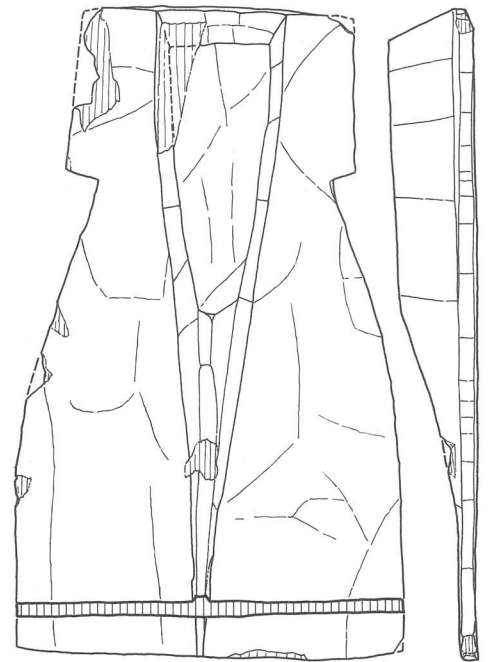

03003

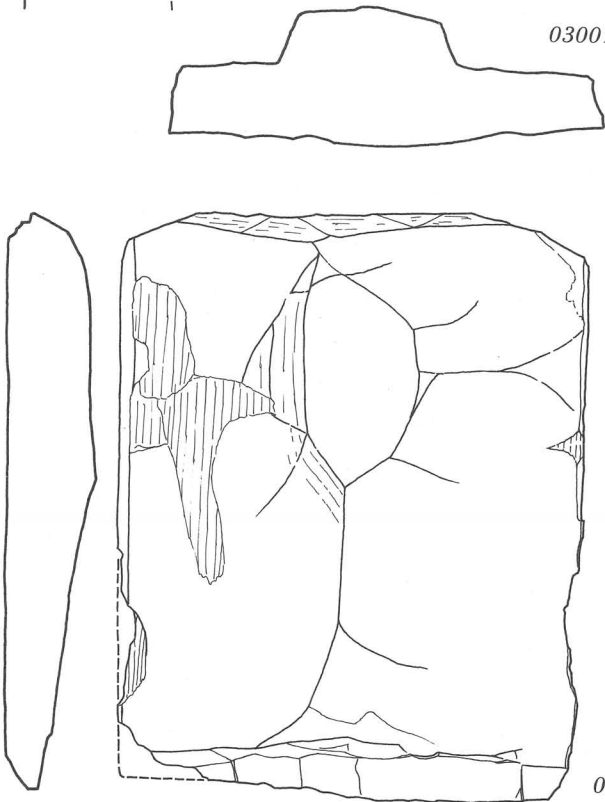

03004

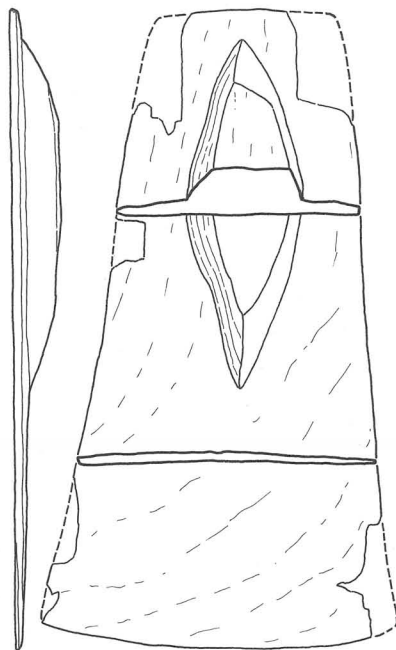

03005



03006

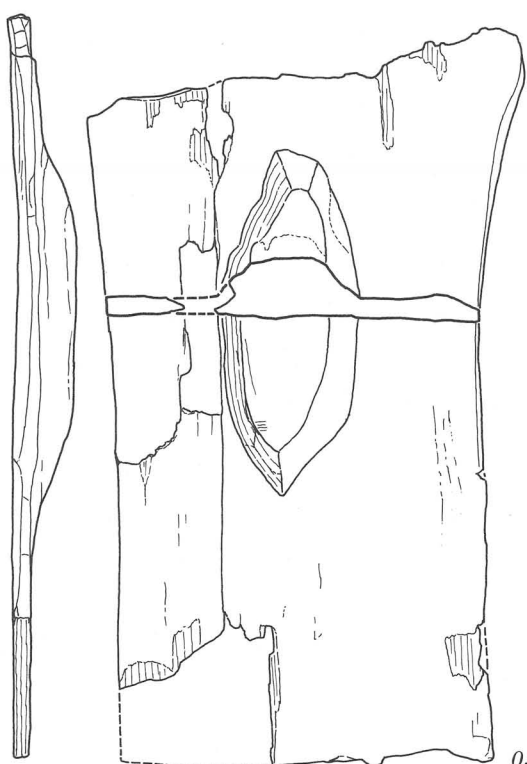

03007

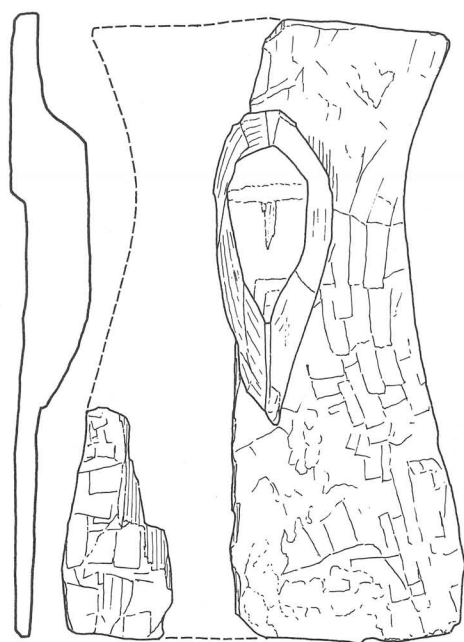

03008

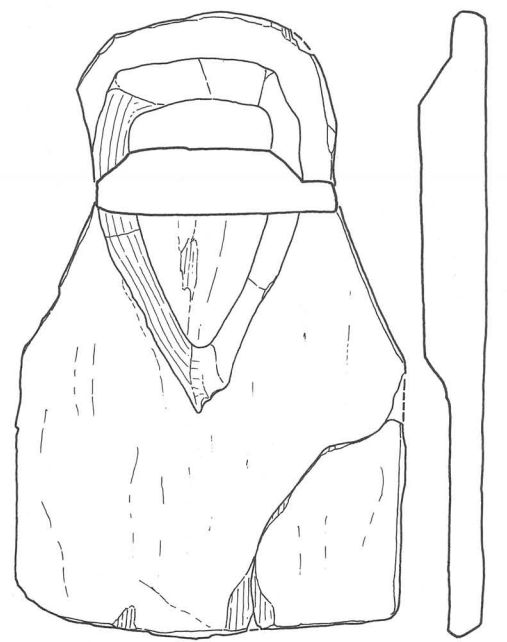

03009



03001；大阪府山賀，03002・03003；大阪府鬼虎川，03004；三重県納所，03005；兵庫県東神吉，03006；大阪府池上，03007；滋賀県川崎，03008；京都府太田、03009；滋賀県服部

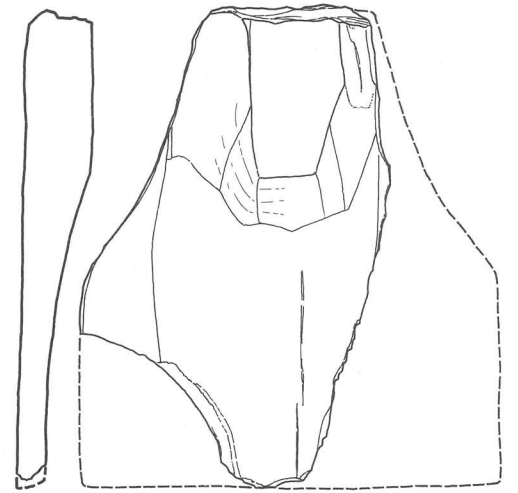
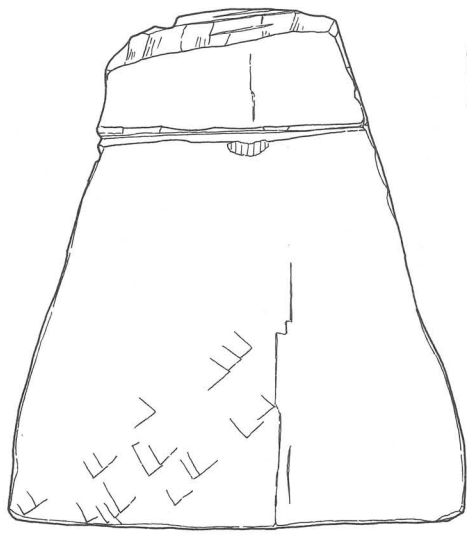

03101

03102

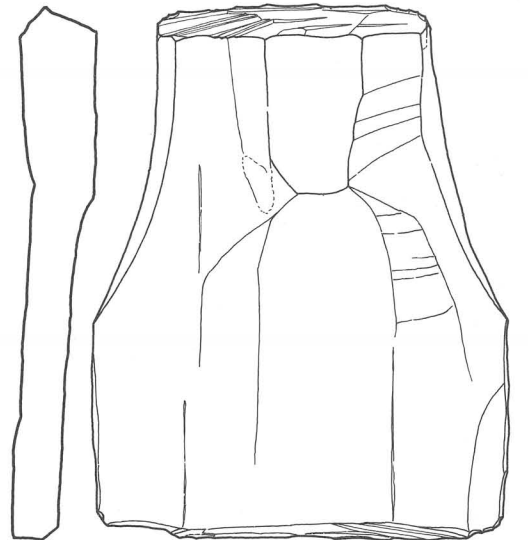
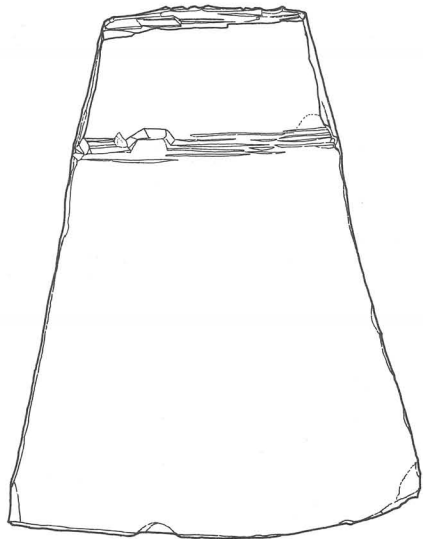

03103

03104

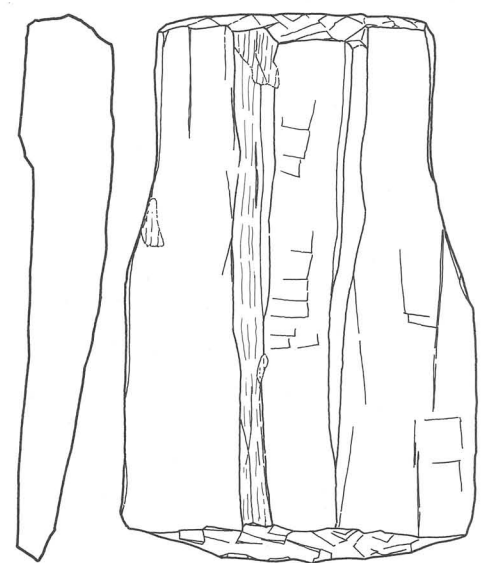
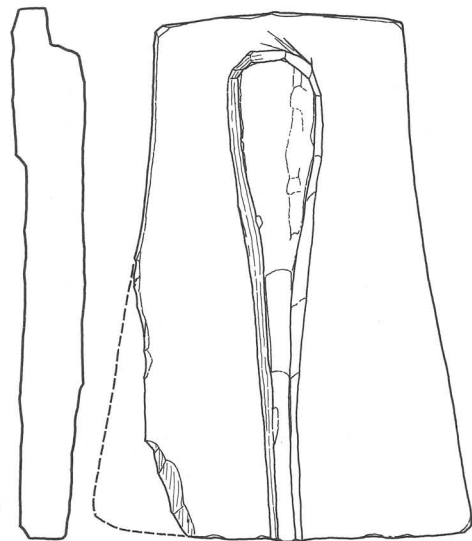
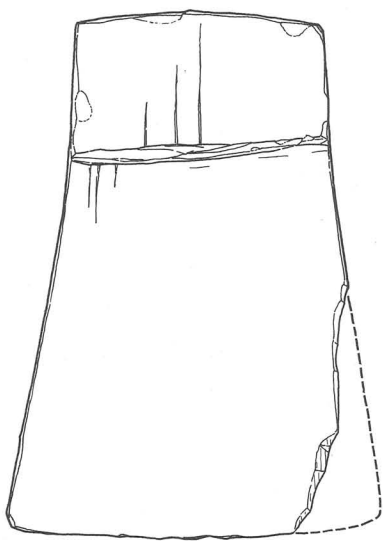

03105

03106

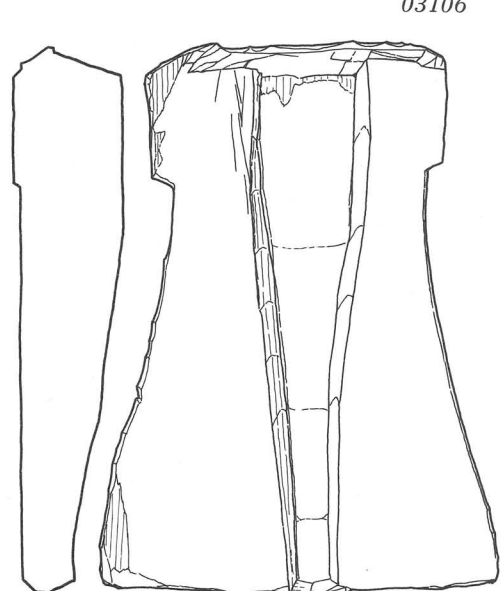
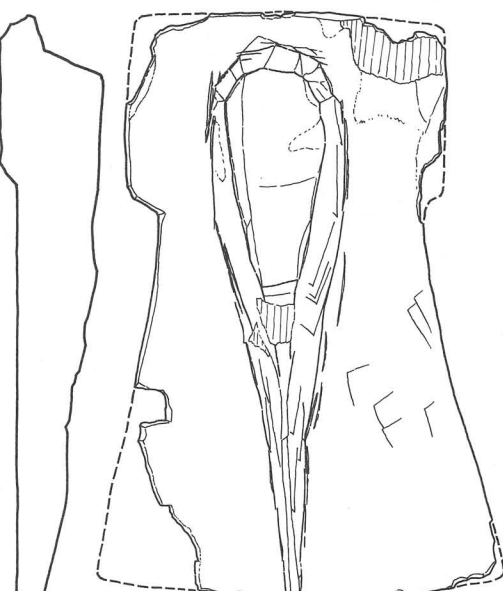
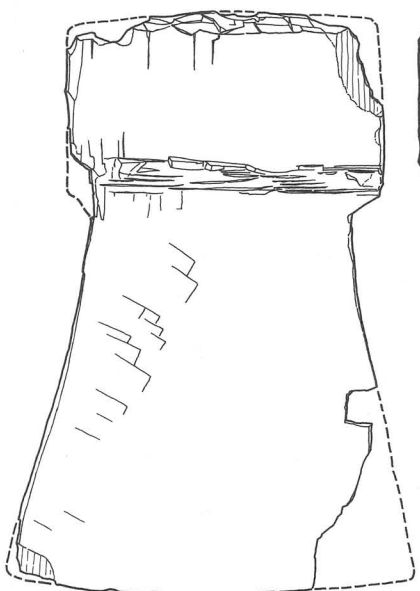

03107

03108



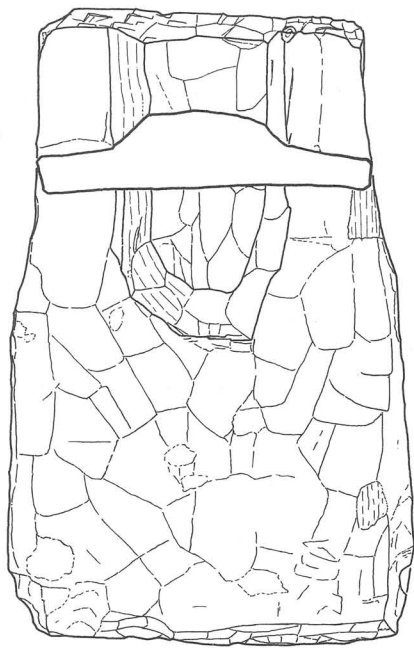
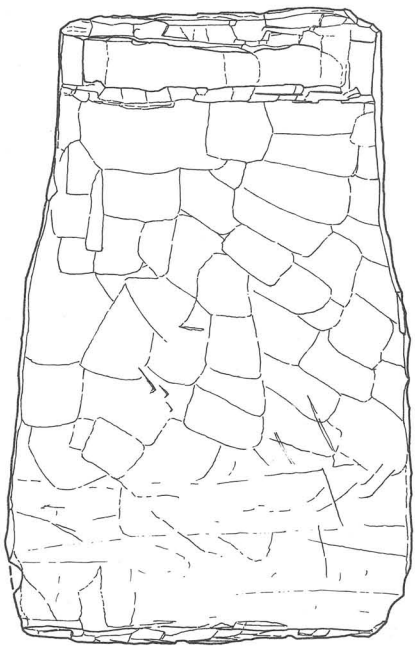

03201

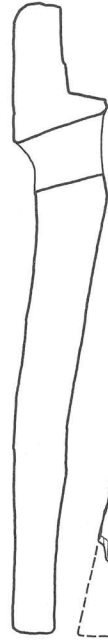
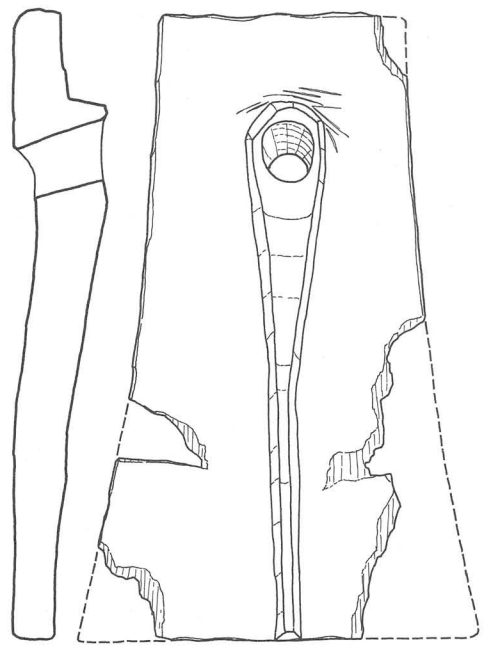

03204

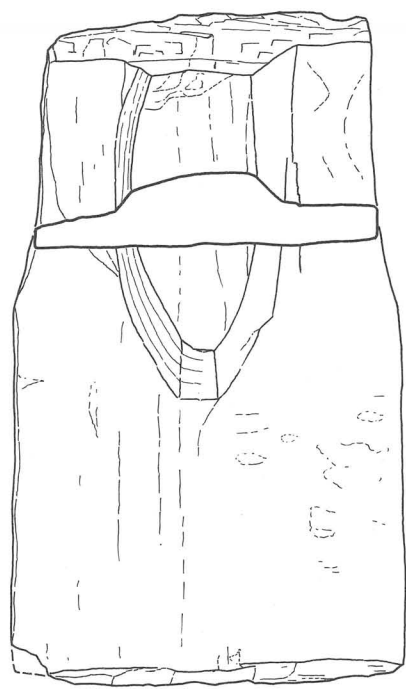
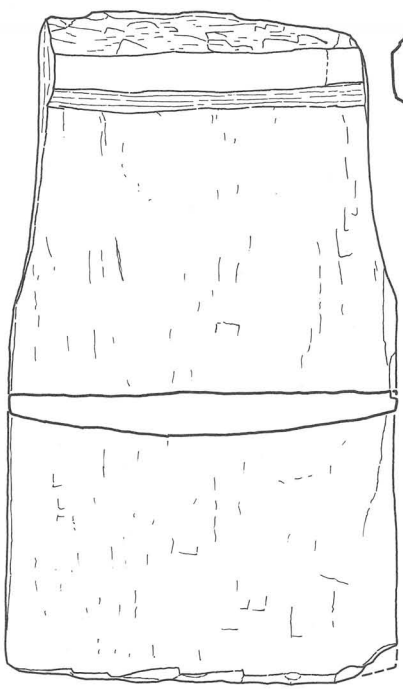

03202



03205

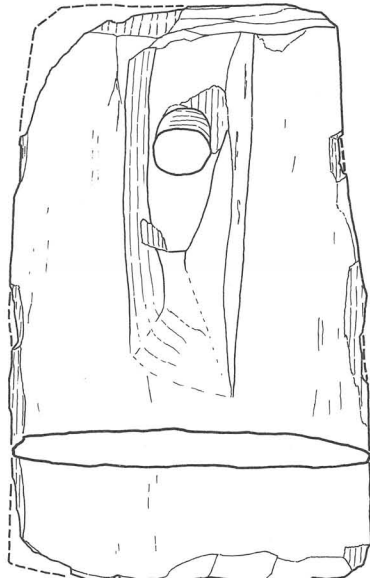
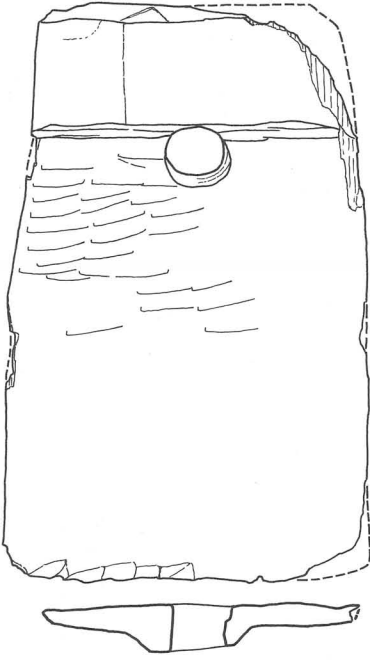

03203

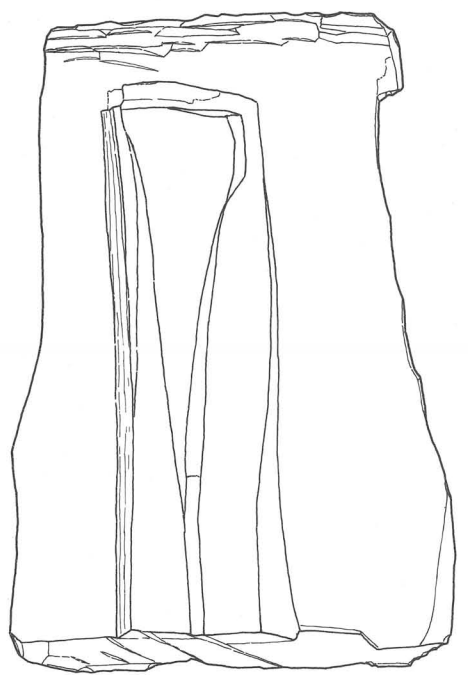
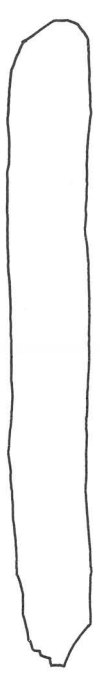

03206



03201・03202；京都府中久世，03203；大阪府東奈良，03204～03206；大阪府池上

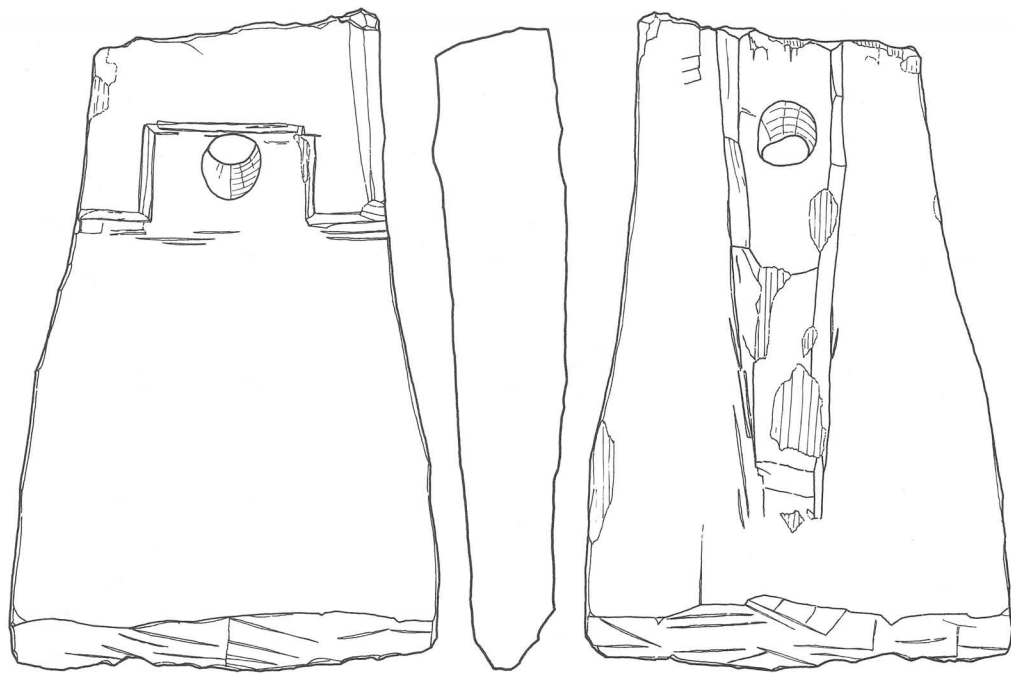

03301

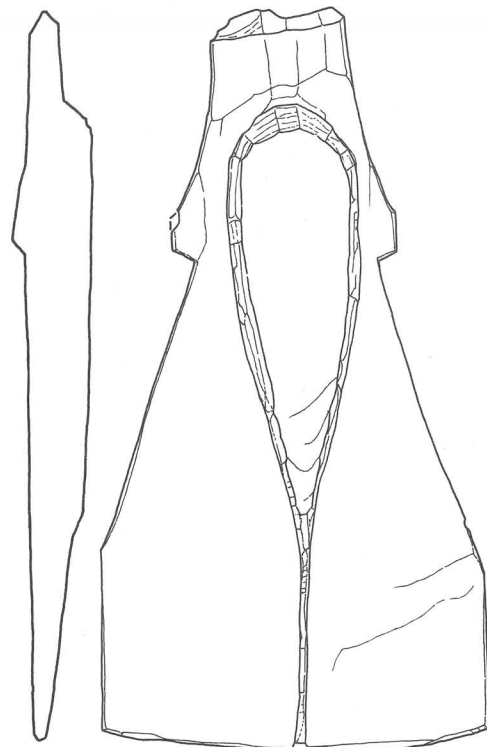

03304

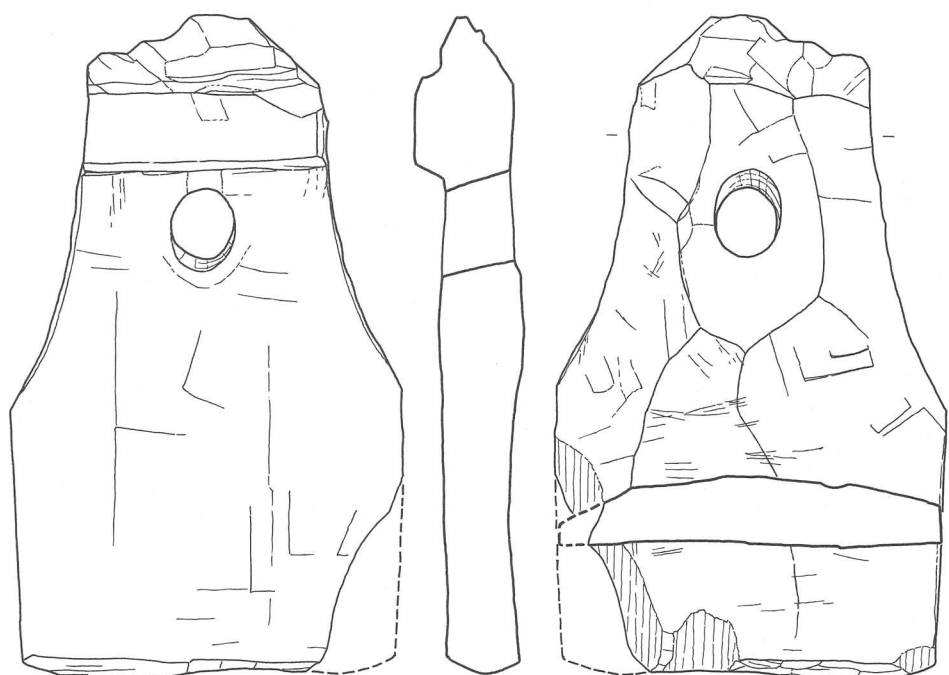

03302

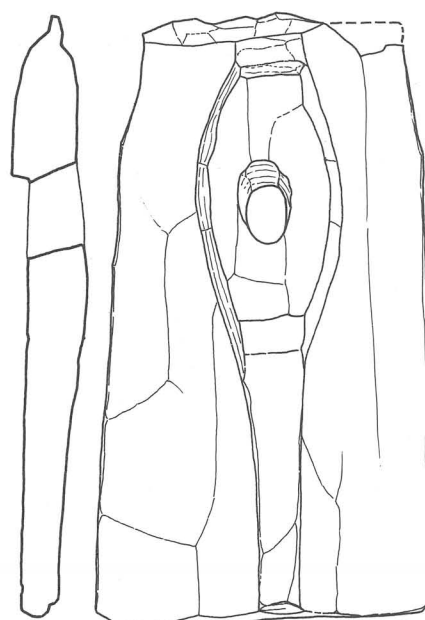

03305

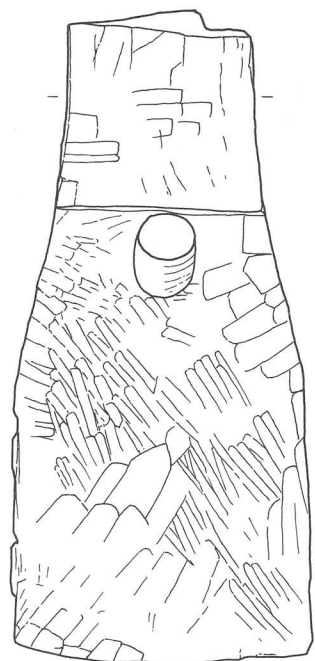
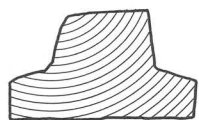

03303

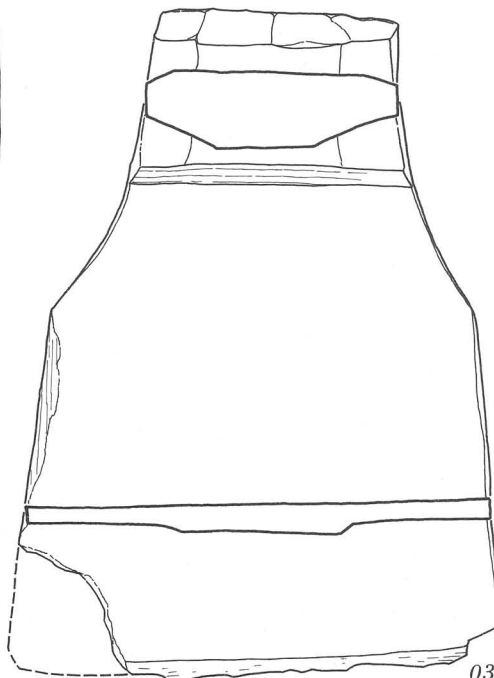
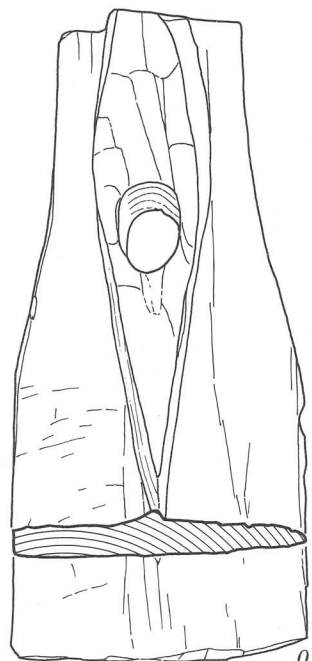
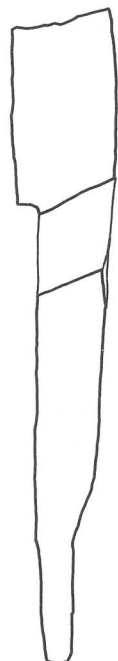

03306



03301 ; 大阪府池上, 03302 ; 大阪府東奈良, 03303 ; 兵庫県新方, 03304 · 03305 ; 滋賀県大中の湖南, 03306 ; 奈良県唐古

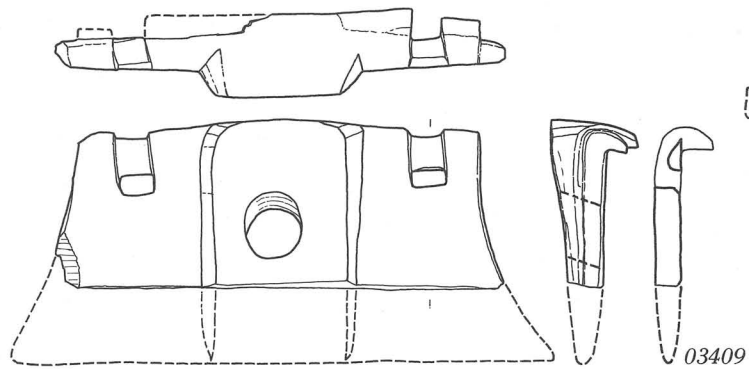
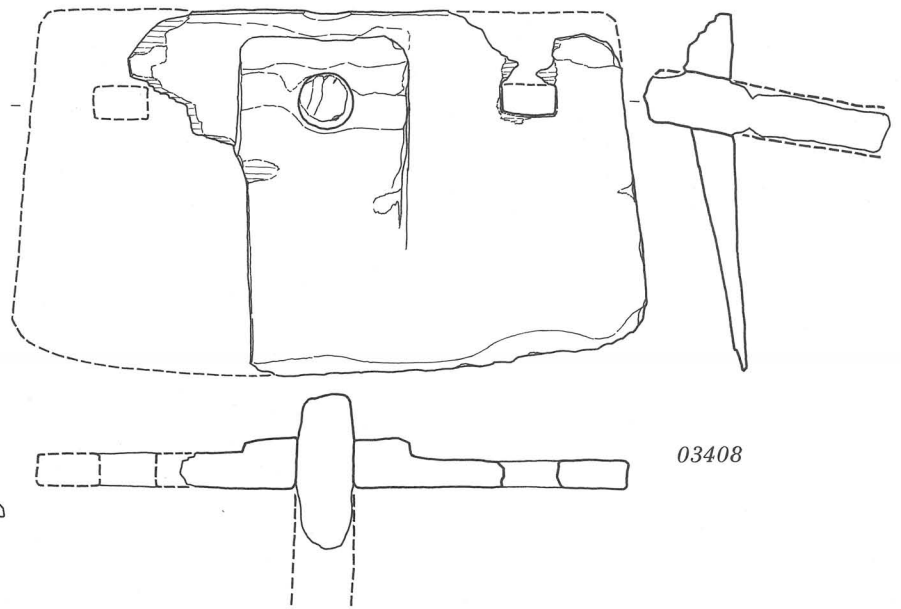
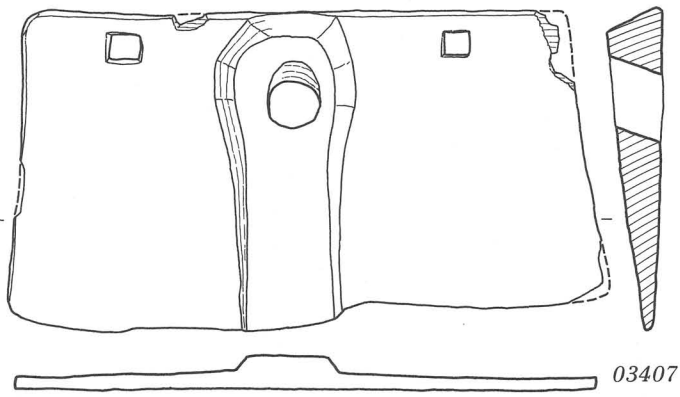
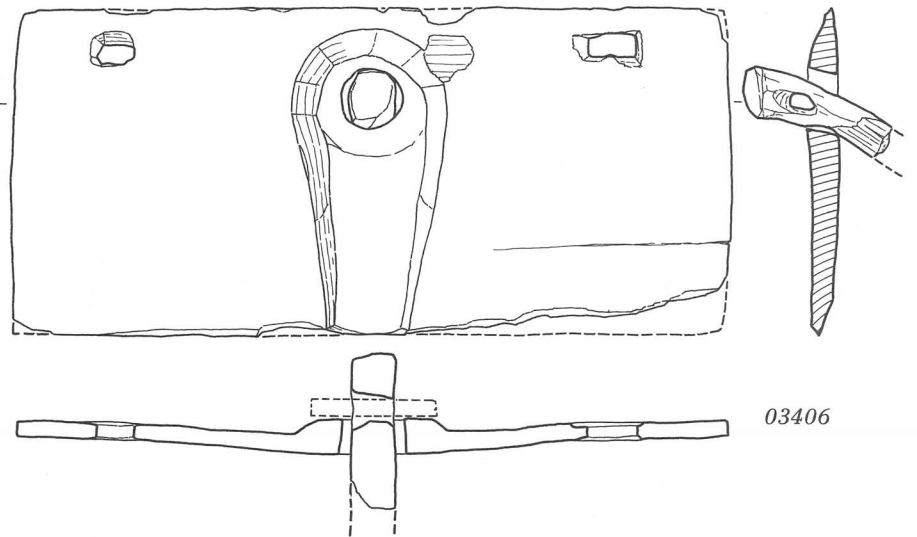
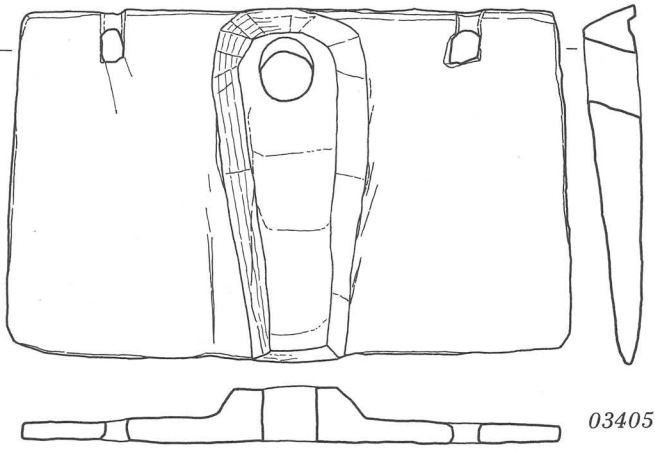
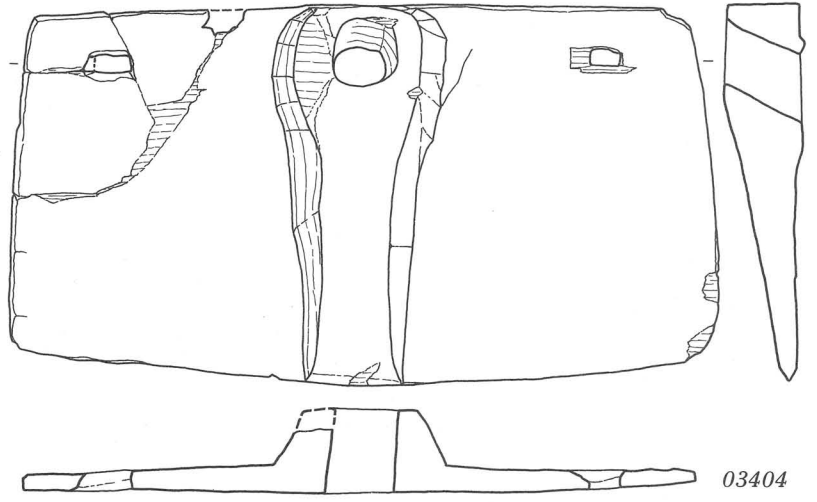
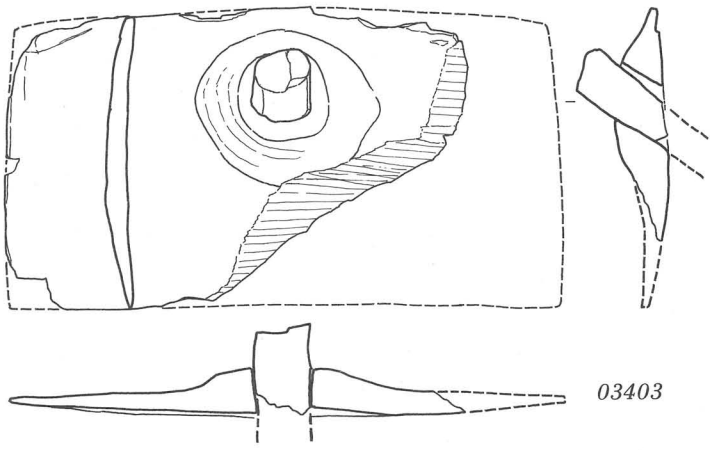
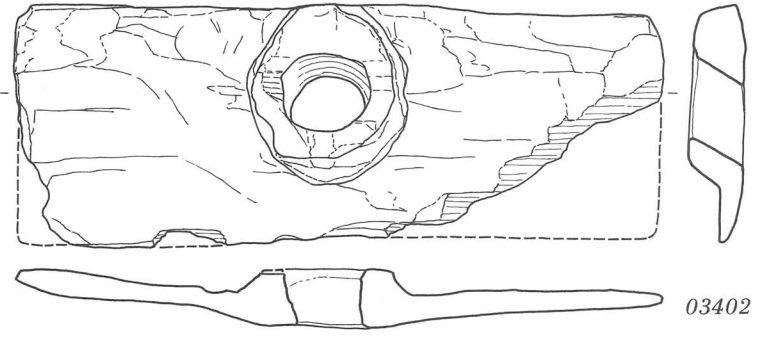
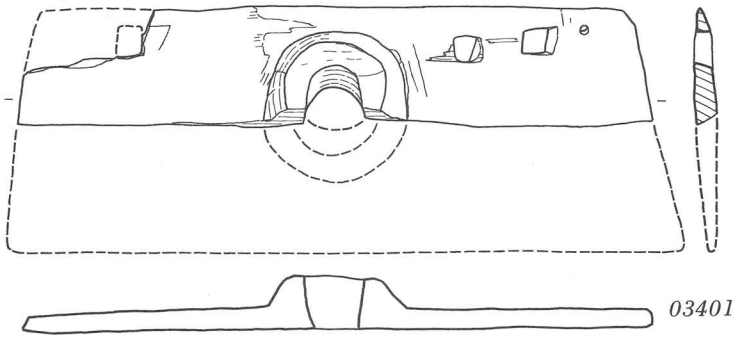

03401；京都府鴨田，03402；大阪府亀井，03403・03406；大阪府瓜生堂，03404・03405；滋賀県服部，03407；兵庫県筒江片引，03408；大阪府池上，03409；滋賀県森浜

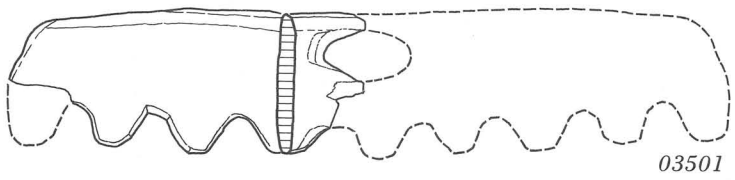

03501

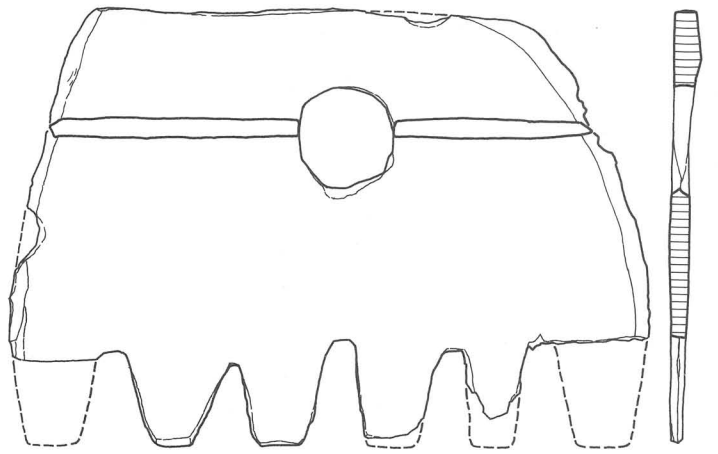

03503

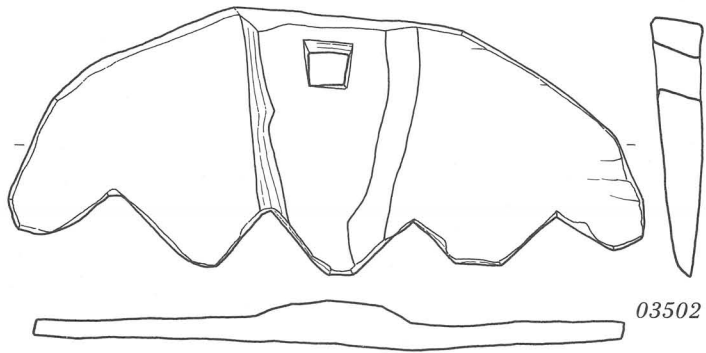

03502

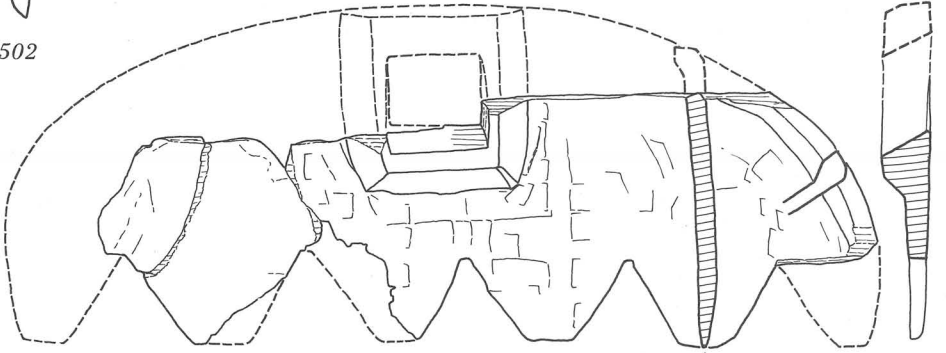

03504

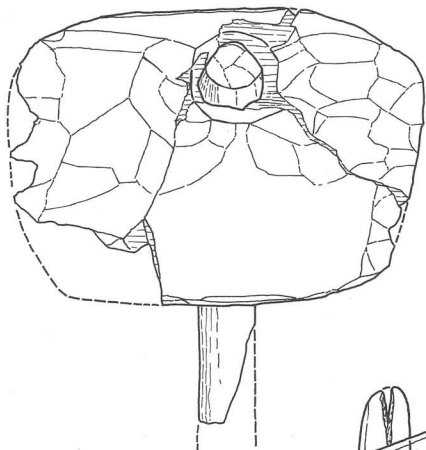

03506

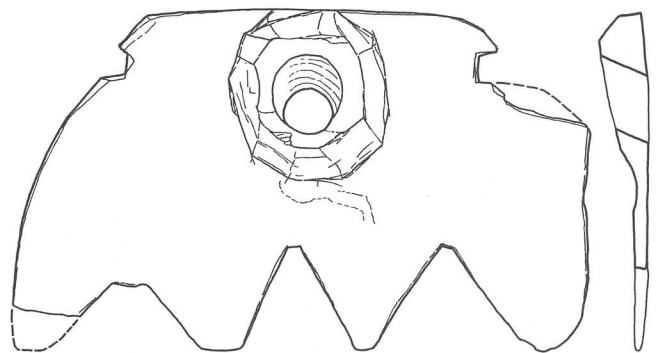
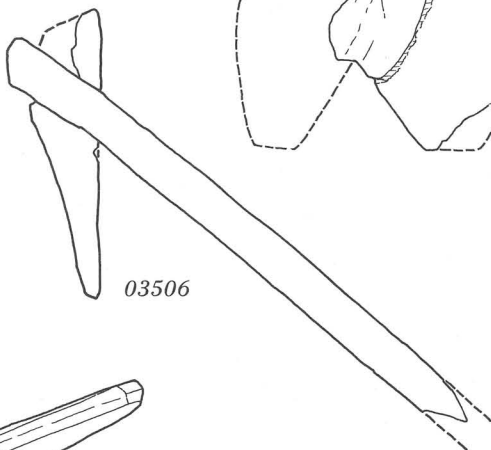

03505

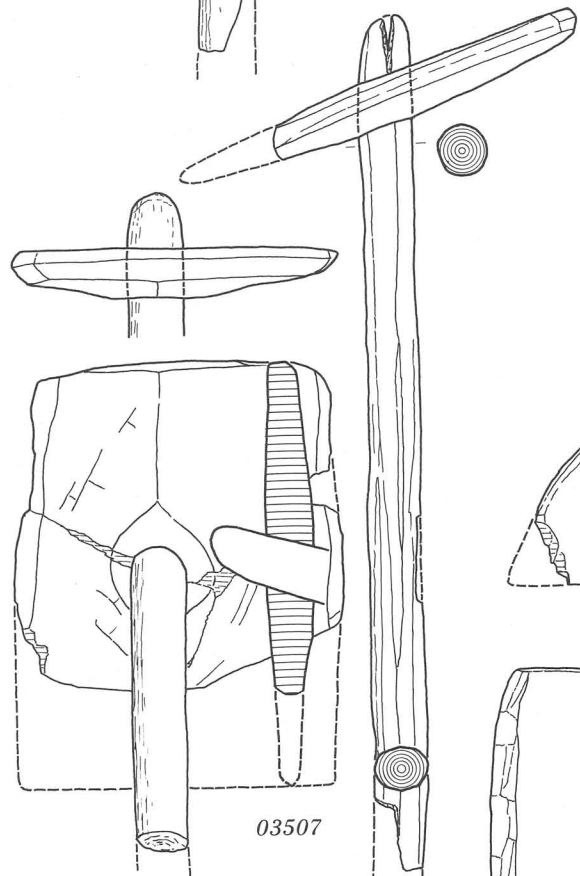

03507

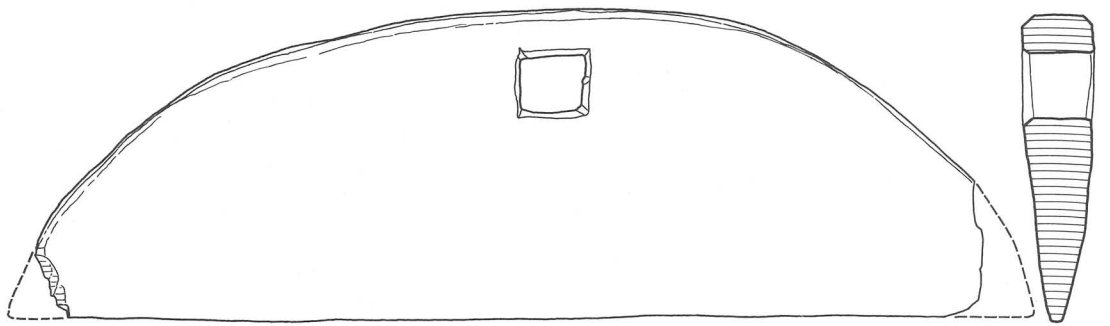

03509

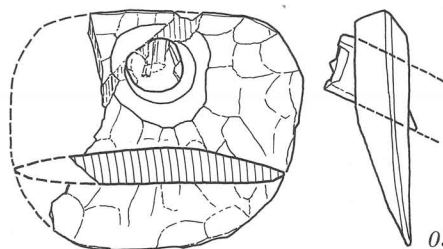

03508

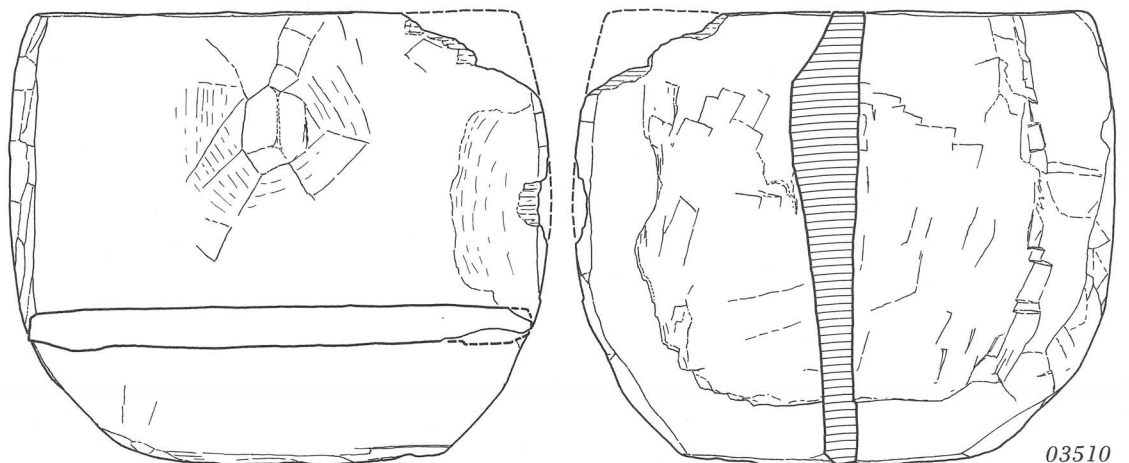

03510



03501 ; 兵庫県播磨長越, 03502 ; 大阪府亀井北, 03503 ; 奈良県平城京下層, 03504 ; 大阪府新家, 03505 ; 大阪府豊中, 03506 ; 大阪府瓜生堂, 03507 · 03508 · 03510 ; 大阪府鬼虎川, 03509 ; 滋賀県湖西線

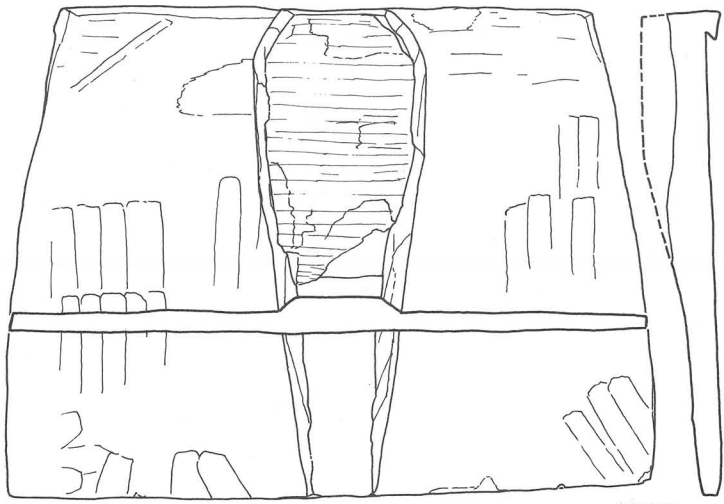

03601

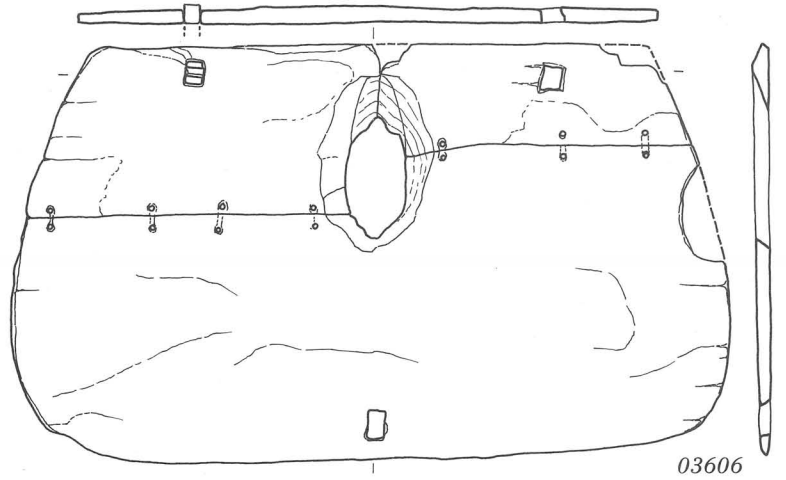

03606

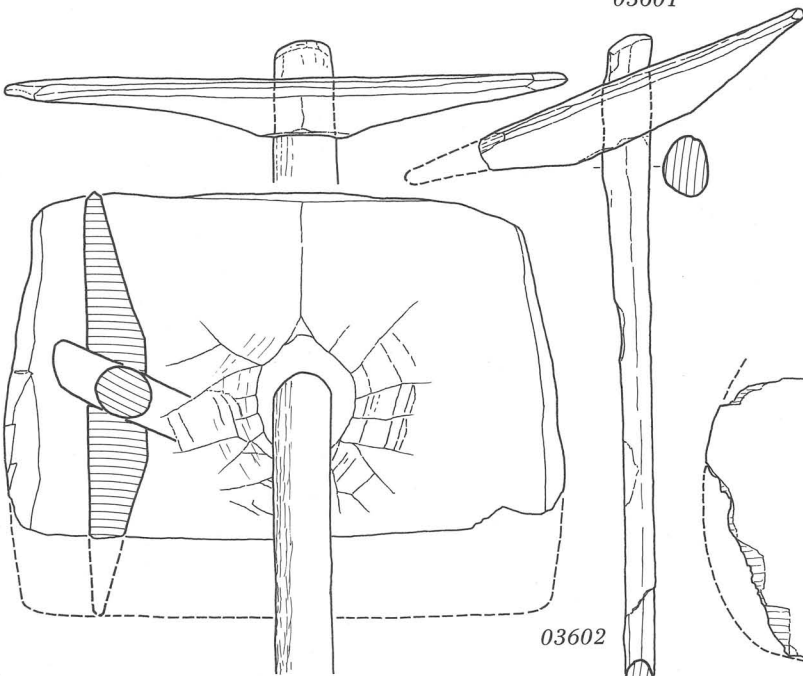

03602

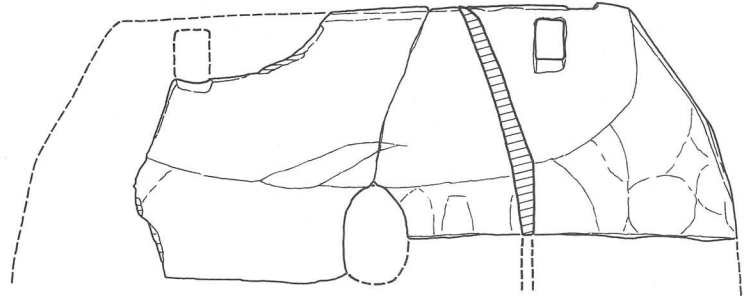

03607

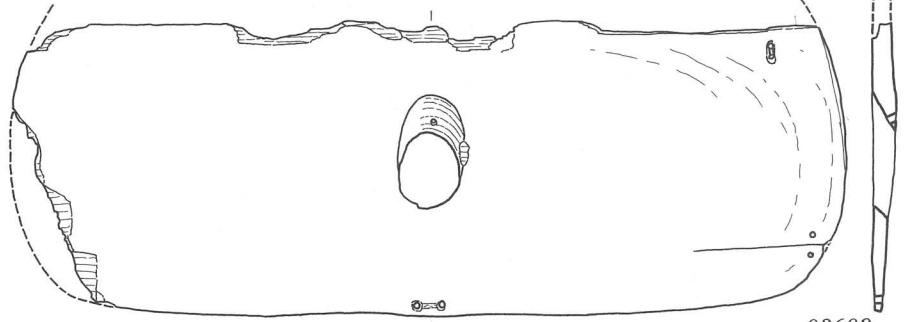

03608

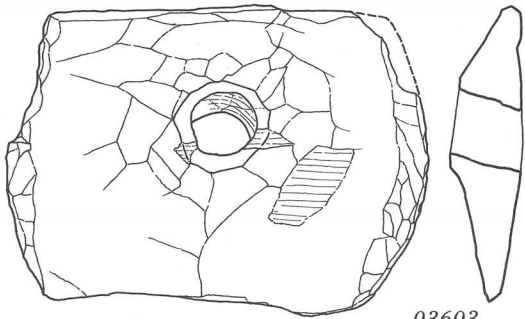

03603

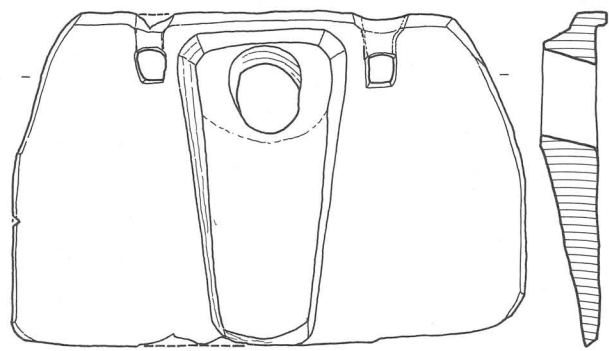

03604

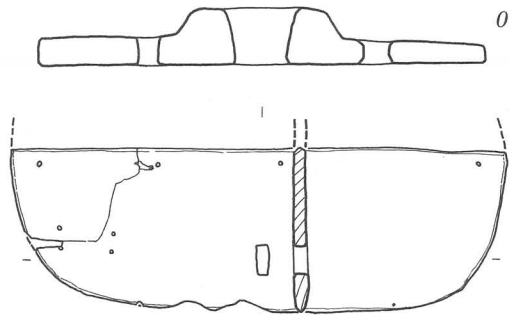

03605

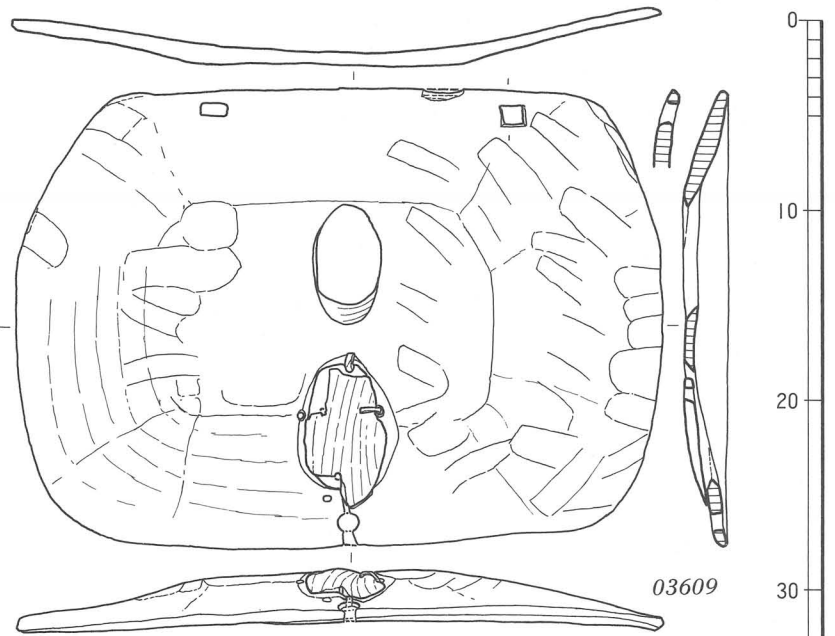

03609

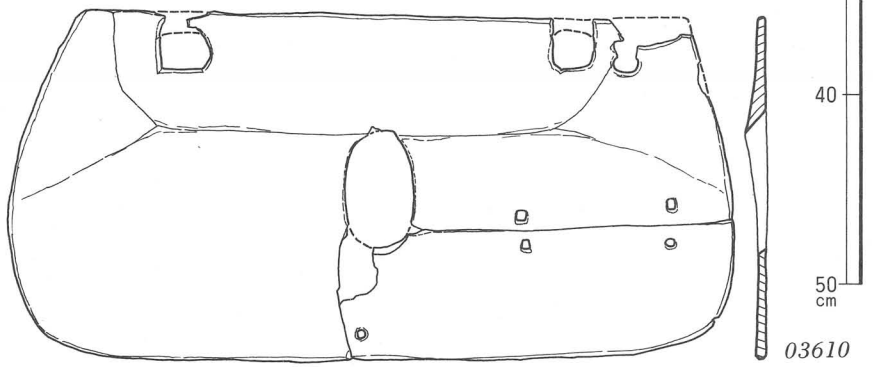

03610



03601；滋賀県旭，03602；大阪府鬼虎川，03603；大阪府瓜生堂，03604；滋賀県入江内湖(丸葎地区)，03605；滋賀県入江内湖(行司町地区)，03606；滋賀県服部，03607・03610；奈良県平城宮下層，03608；三重県納所，03609；京都府下八ノ坪

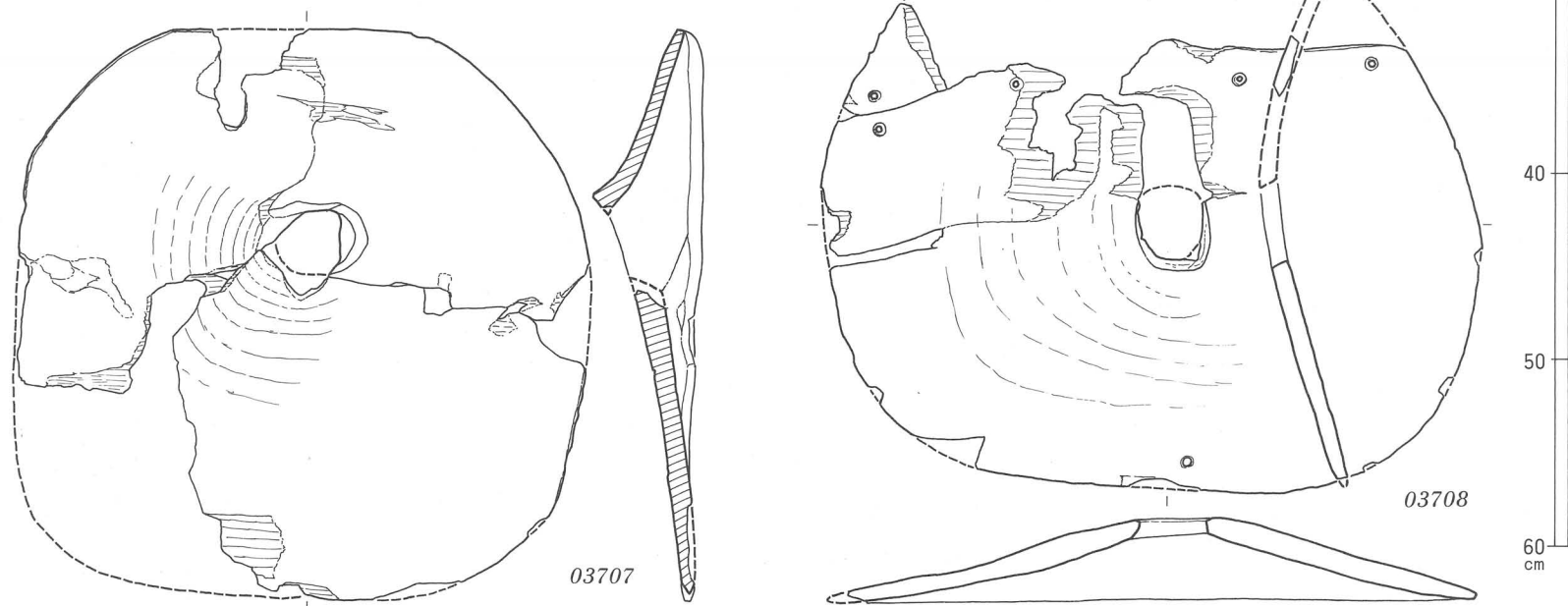
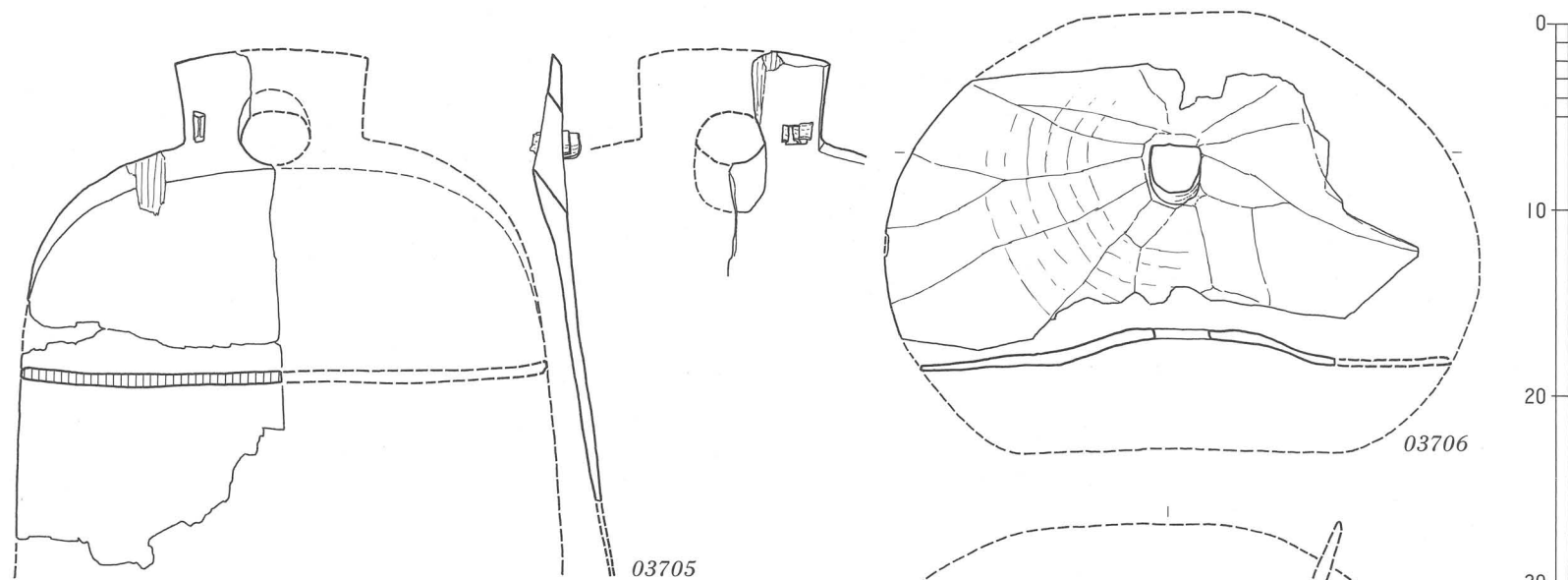
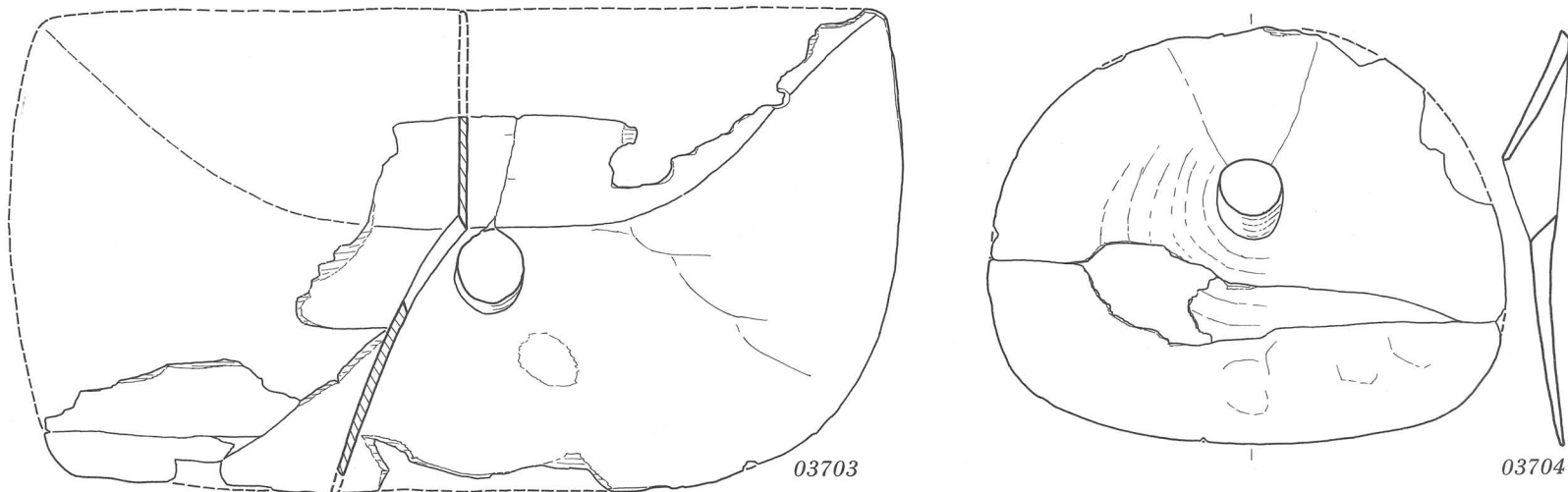
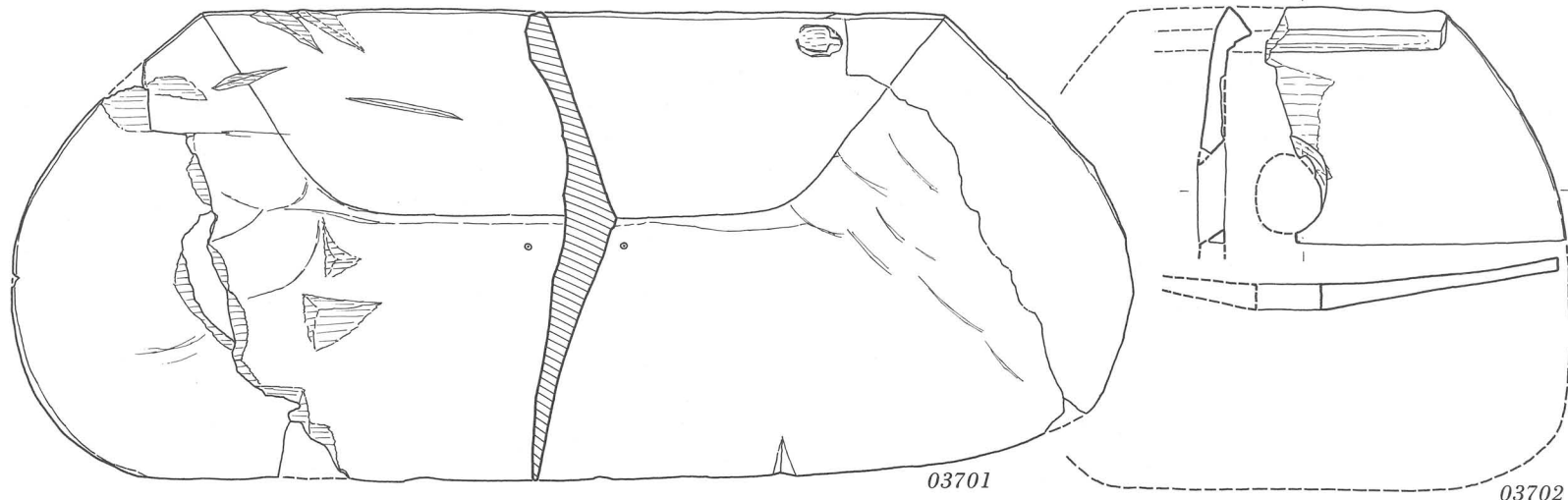

03701；奈良県平城京下層， 03702；奈良県四分， 03703；兵庫県丁・柳ヶ瀬， 03704；三重県納所， 03705；滋賀県入江内湖（行司町地区）， 03706；滋賀県大中の湖南， 03707；京都府深草， 03708；大阪府山賀

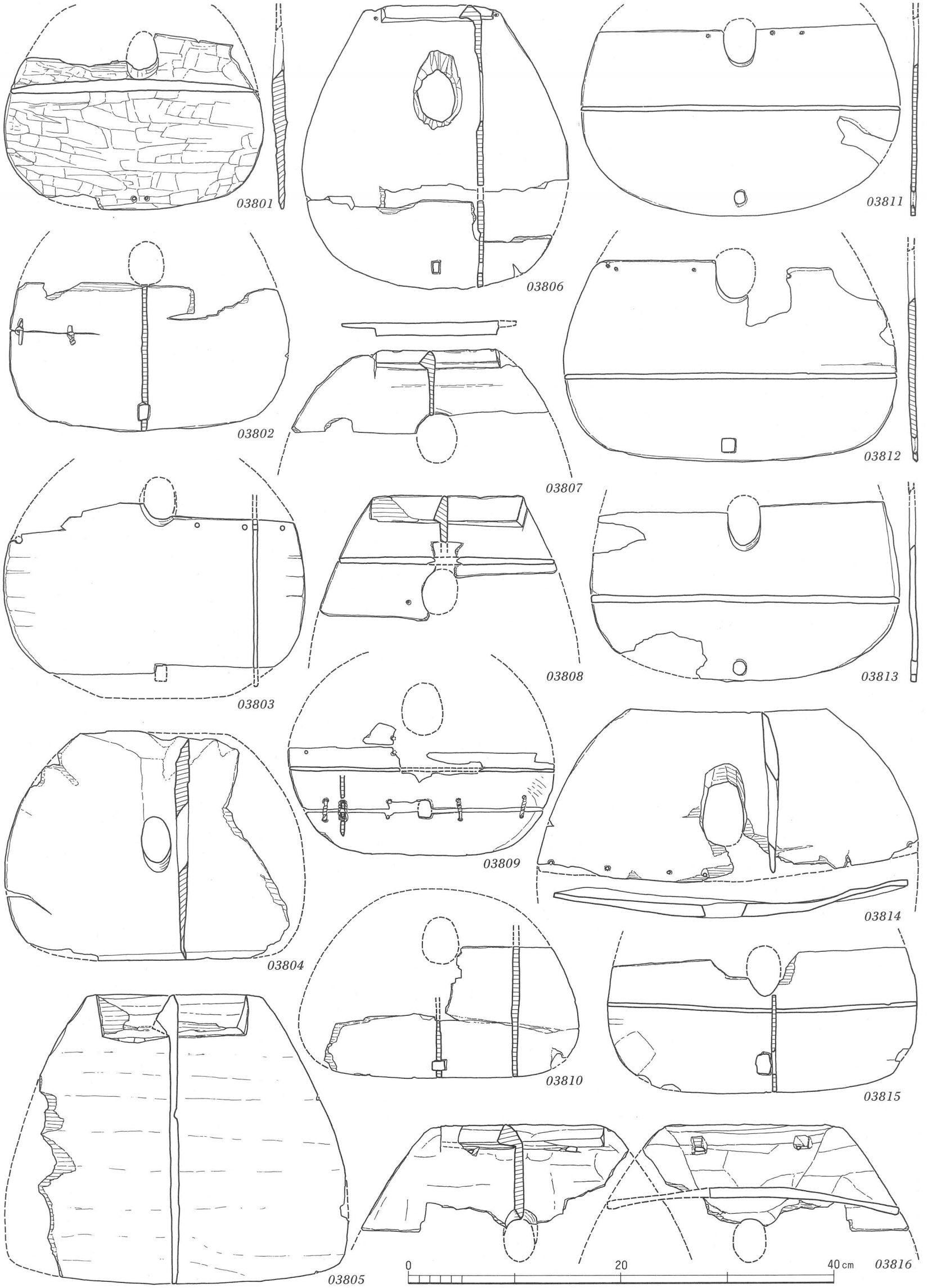

03801；大阪府西岩田，03802・03806；滋賀県赤野井湾，03803；奈良県纏向，03804；三重県北堀池，03805；京都府岡崎，03807・03810；奈良県平城宮下層，03808・03812；滋賀県入江内湖(行司町地区)，03809；滋賀県森浜，03811；大阪府亀井，03813；兵庫県玉津田中，03814；奈良県唐古・鍵，03815；大阪府加美，03816；大阪府山賀

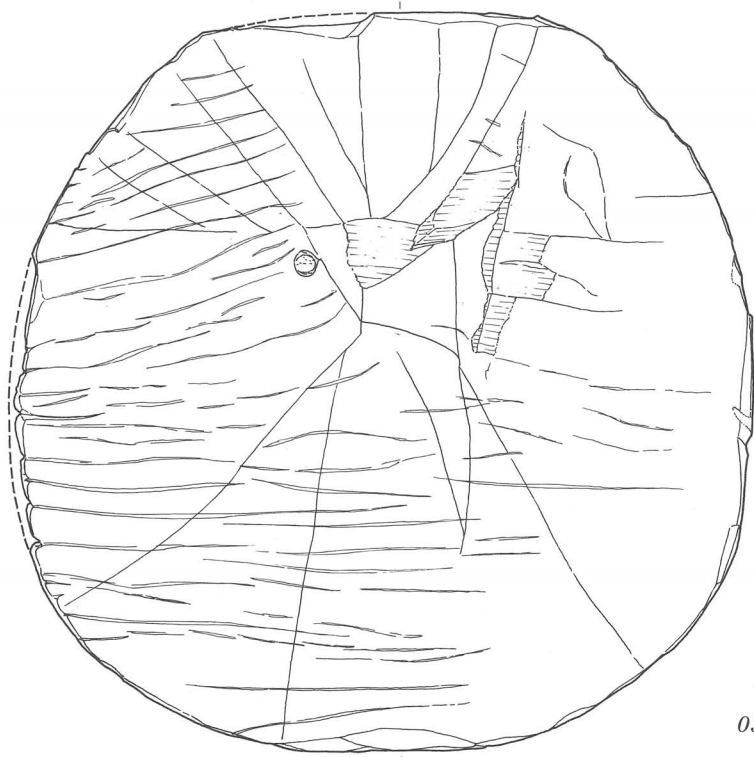

03901

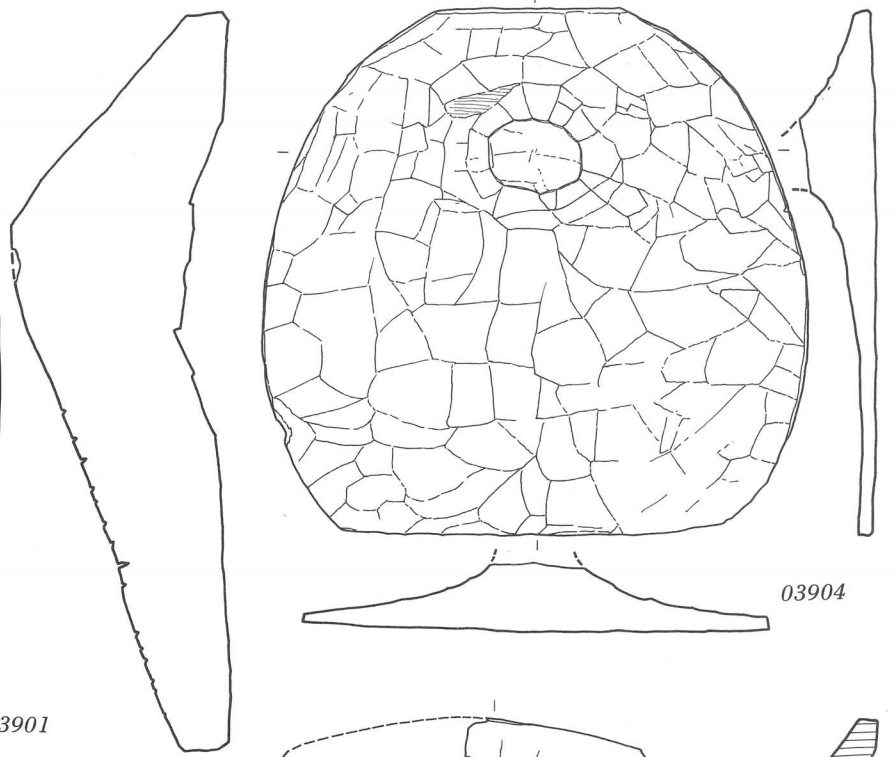

03904

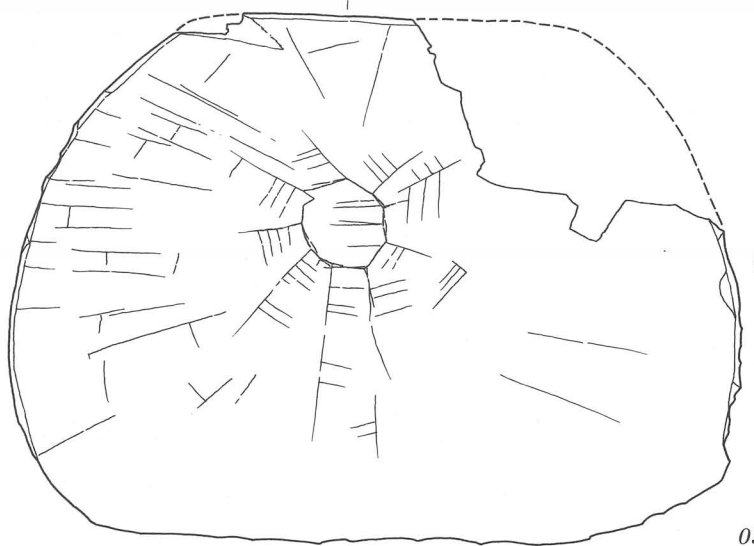

03902

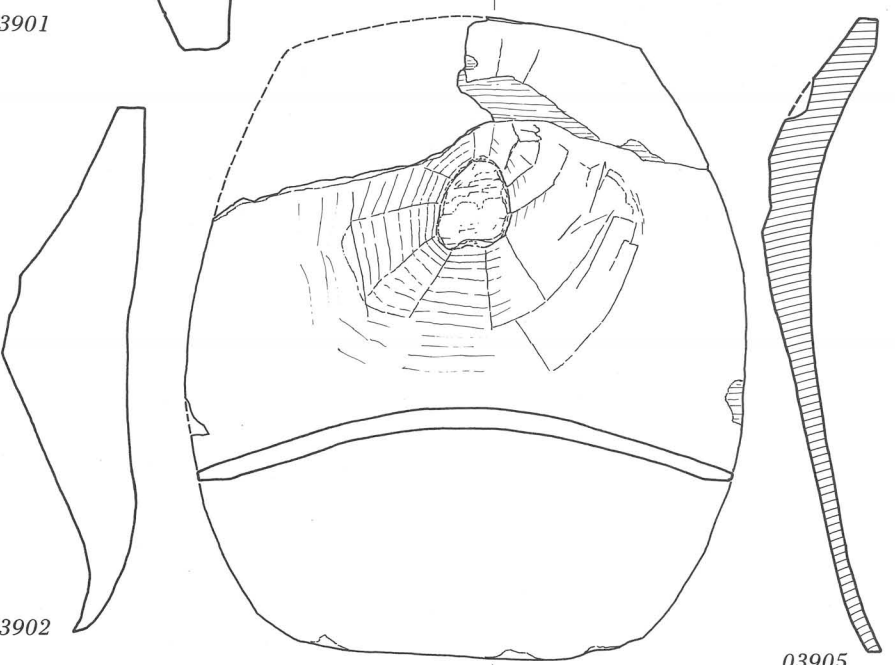

03905

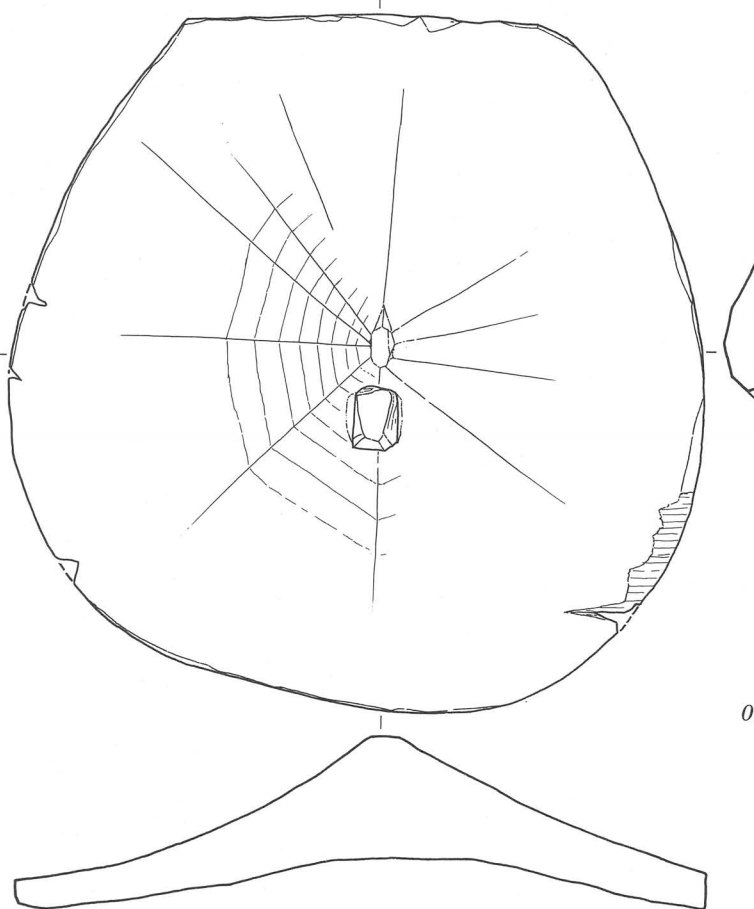

03903

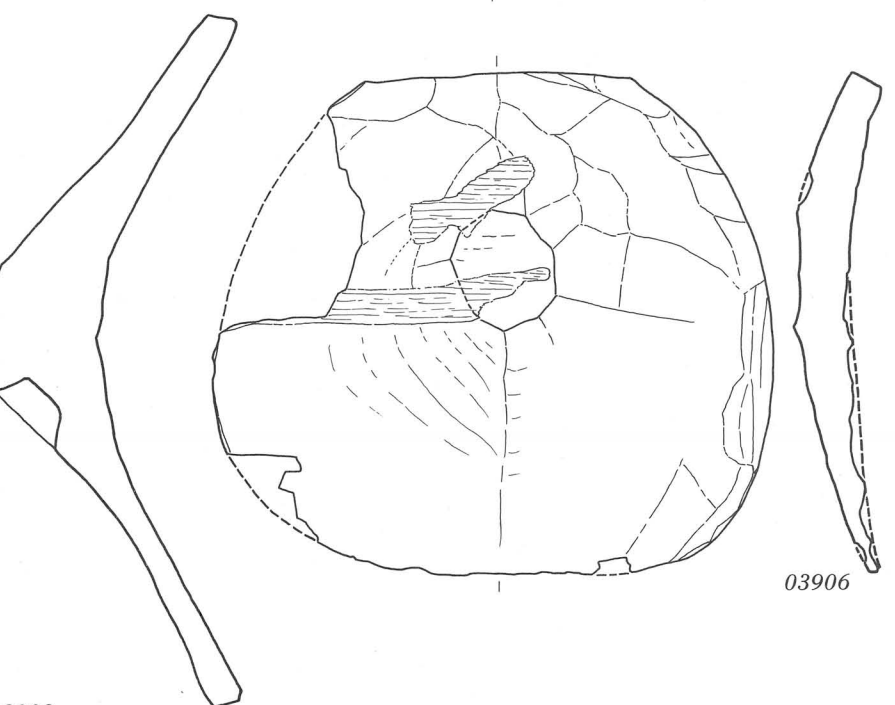

03906

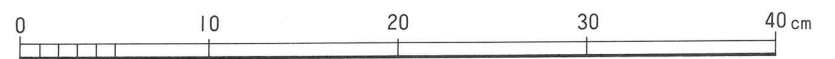

03901 ; 大阪府池上, 03902 ; 大阪府安満, 03903 ; 三重県納所, 03904 ; 京都府中久世, 03905 ; 大阪府鬼虎川, 03906 ; 大阪府東奈良



04001

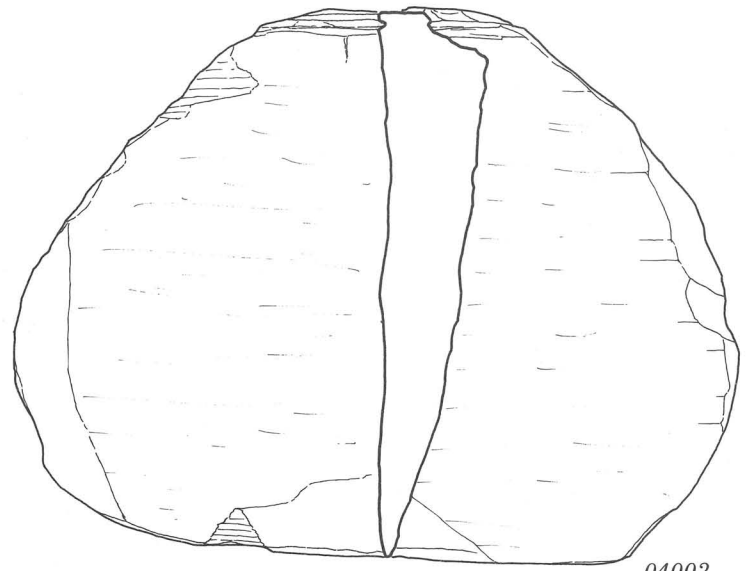

04002

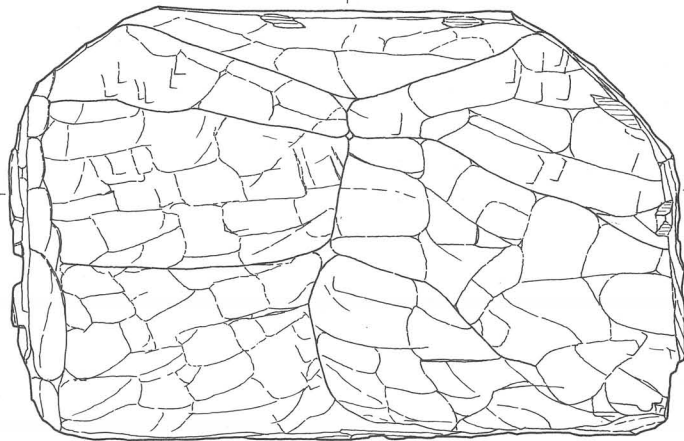
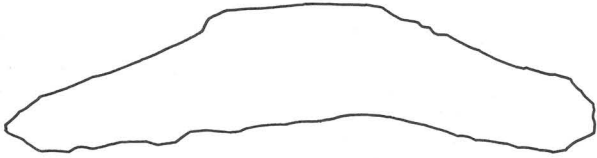

04003

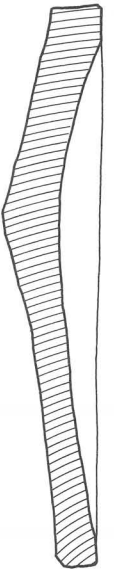
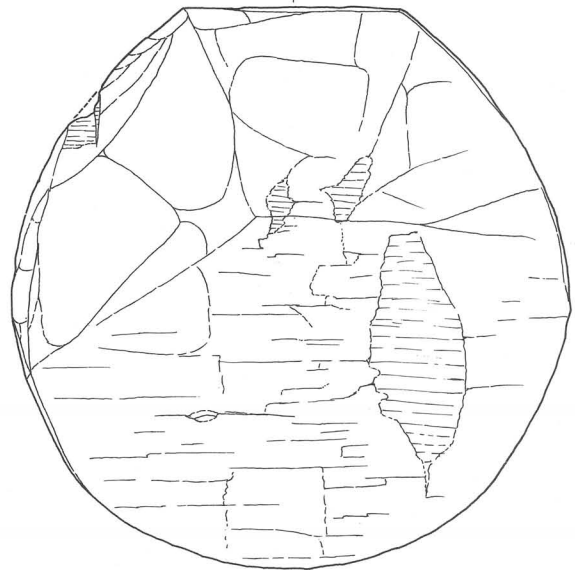

04004

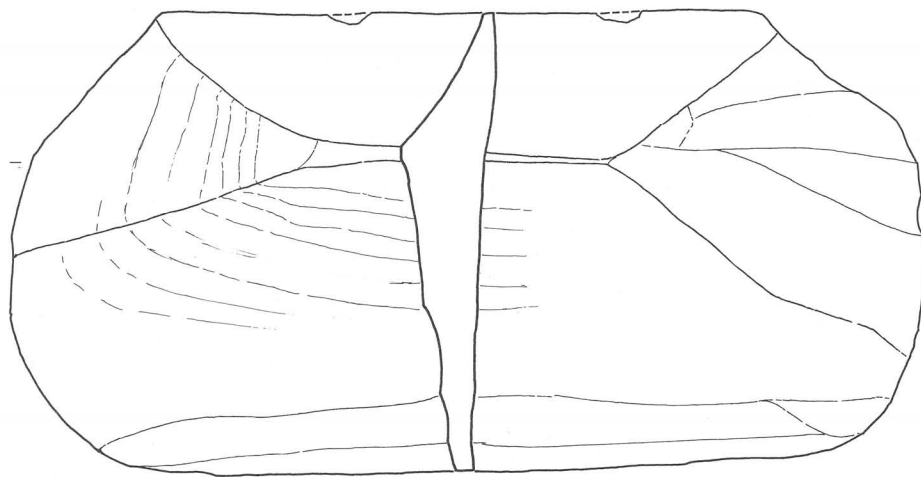

04005

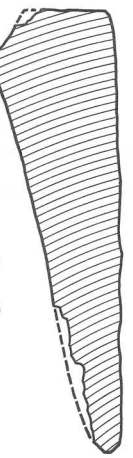
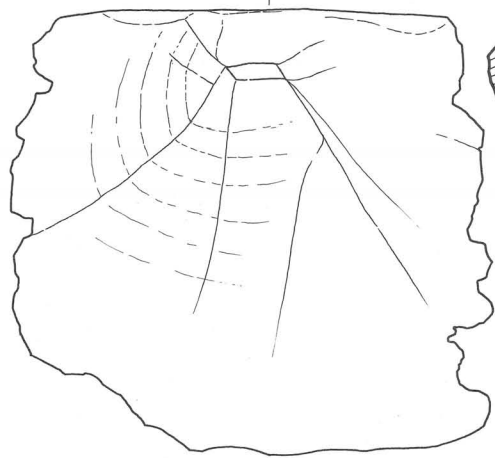

04006

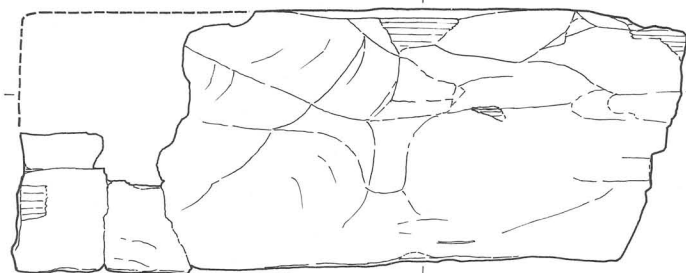

04007

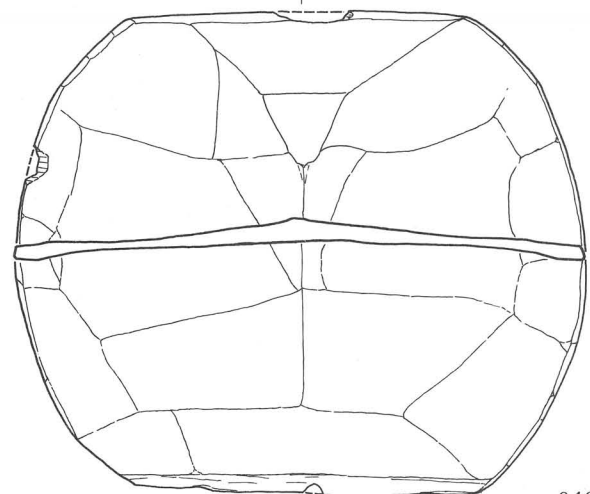

04008

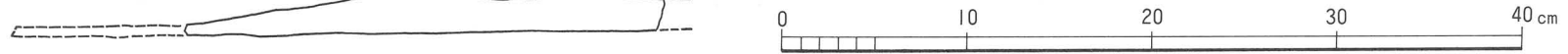

04001；大阪府東奈良，04002；滋賀県服部，04003・04008；京都府中久世，04004；三重県納所，04005；京都府岡崎，04006；滋賀県鴨田，04007；大阪府亀井