

1 かぶせ面戸瓦

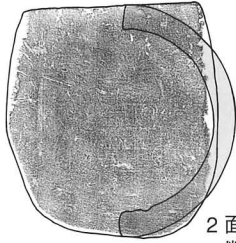

2 面戸瓦
断面半円

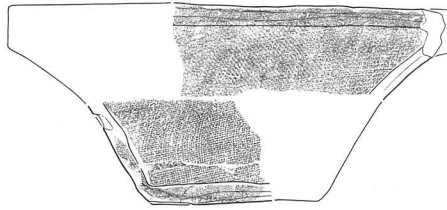
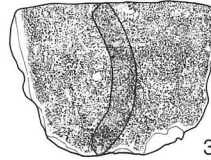

3 面戸瓦か

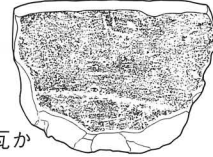

4 面戸瓦
焼成前加工

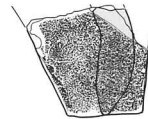

5 登り
面戸瓦か

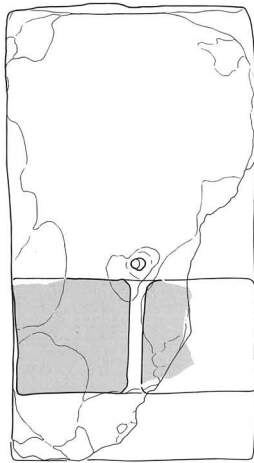

1 塼 中央部穿孔

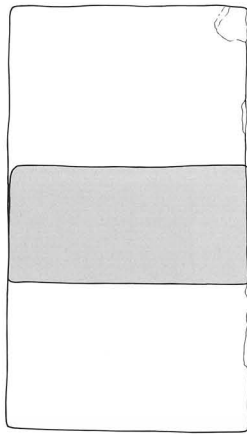

2-1 長方形 塼

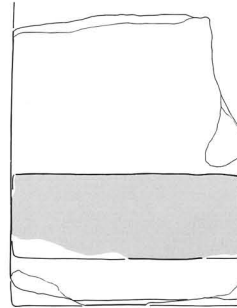

2-2 塼 薄いもの

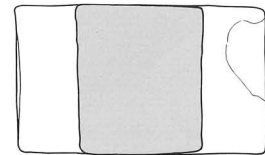

2-3 塼 長さ1/3程度のもの

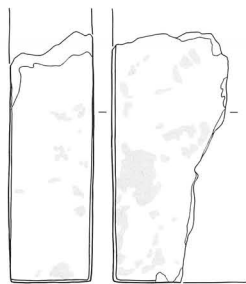

3-1 緑釉塼(1)

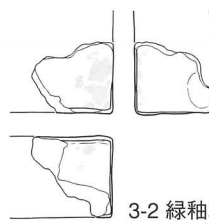

3-2 緑釉塼(2)

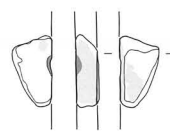

3-3 緑釉塼(3)

3-4 二彩熨斗瓦

凡例

緑釉

褐釉(3-4のみ)

0 30cm



2 面戸瓦 断面半円



1 かぶせ面戸瓦



3 面戸瓦か



4 面戸瓦 焼成前加工



5 登り面戸瓦か



1 塼 中央部穿孔



2 塼各種集合



3 施釉瓦塼集合



4 SB8490 柱穴出土 根巻石

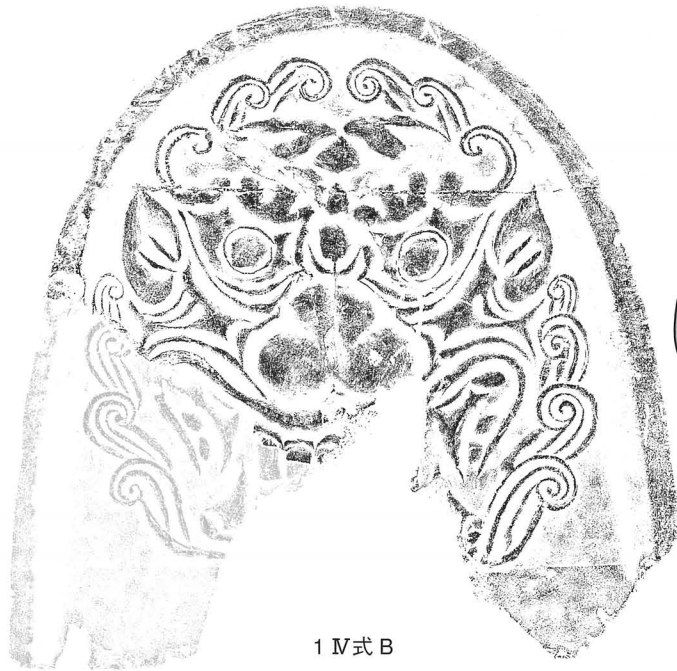

1 IV式 B

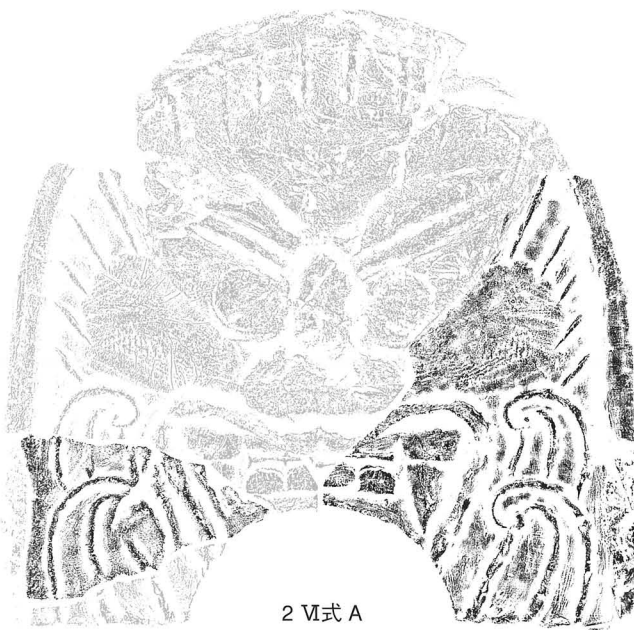

2 VI式 A

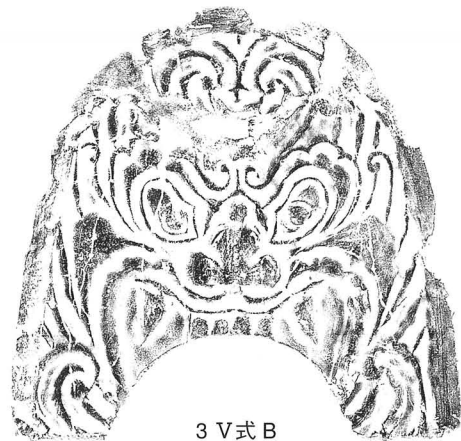
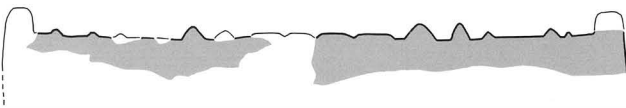

3 V式 B

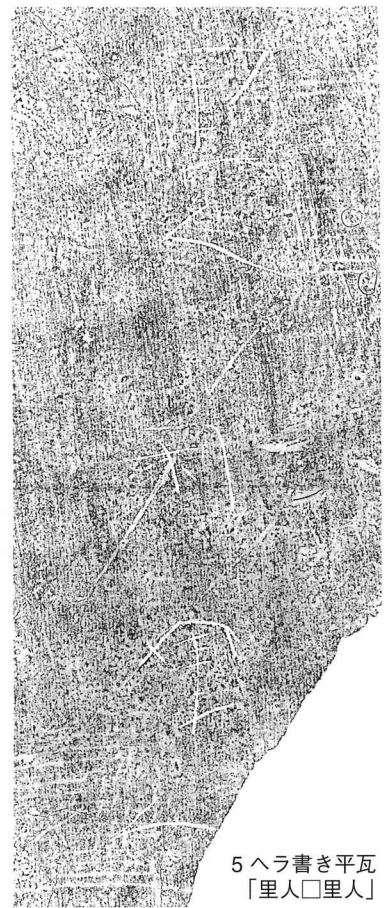

5 ヘラ書き平瓦
「里人□里人」



3 ヘラ書き平瓦
「十九日作」



1 ヘラ書き平瓦
「キ」



4 ヘラ書き平瓦「十」



3 V式B



1 IV式B



2 VI式A



4 V式A



5 III式

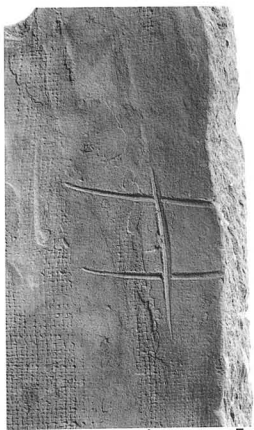

1 ヘラ書き平瓦「キ」



3 ヘラ書き平瓦「十九日作」



5 ヘラ書き平瓦「里人□里人」

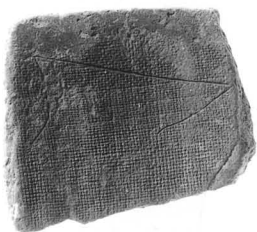

2 ヘラ書き平瓦 記号か



4 ヘラ書き平瓦「十」

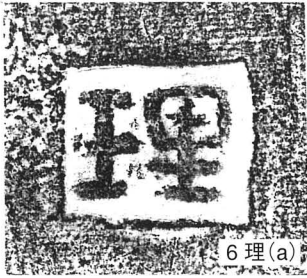

6 理(a)



7 理(d)



8 理(g)



9 理(h)



10 理(j)



11 理(i)

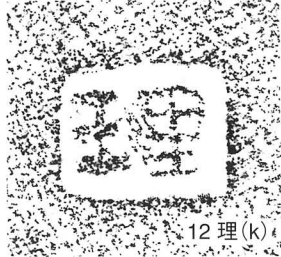

12 理(k)



13 修(e)



14 三

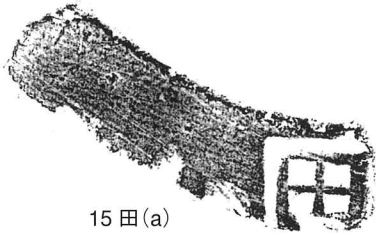

15 田(a)



16 在(a)



17 里(a)

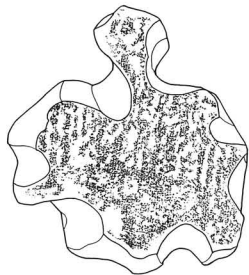

19-1 平瓦 不整方向穿孔



19-2. 平瓦 凸面凹線



18 夫

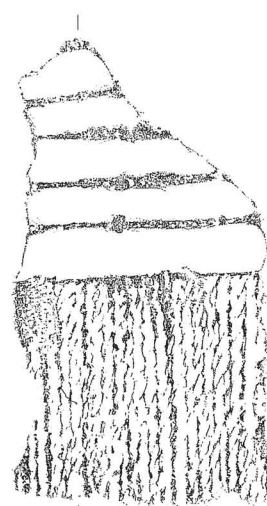

19-3. 平瓦 円形圧痕

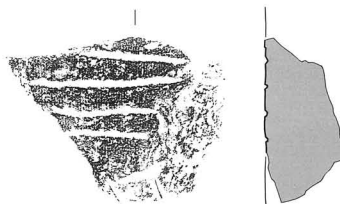

19-4. 水波文塼か

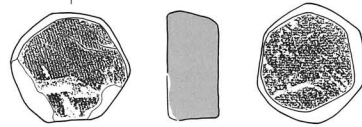

19-5. 瓦製 円盤



6 理 (a)



7 理 (d)

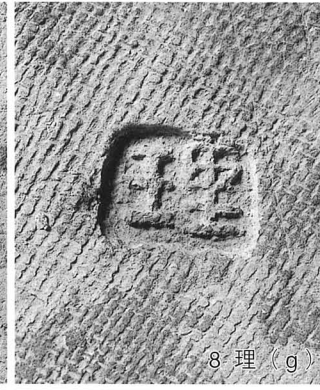

8 理 (g)

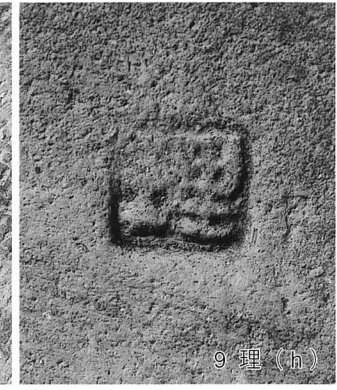

9 理 (h)

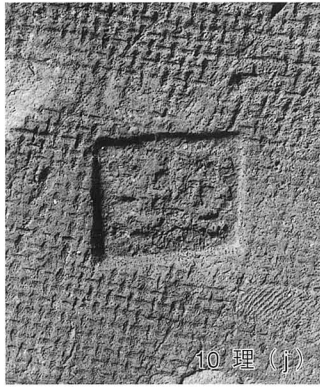

10 理 (j)

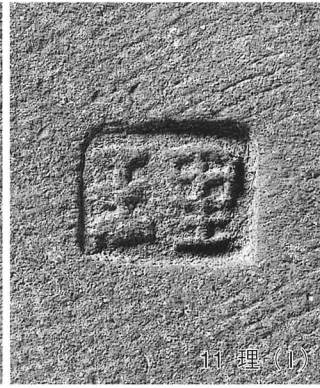

11 理 (l)

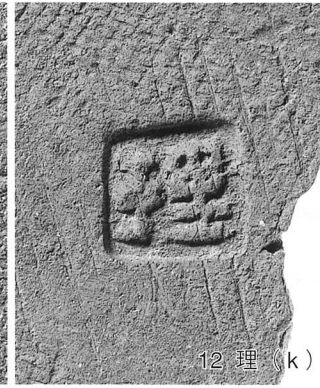

12 理 (k)



13 修 (e)



14 三



15 田 (a)



16 在 (a)



17 里 (a)



18 夫



19 そのほかの
瓦埴類集合

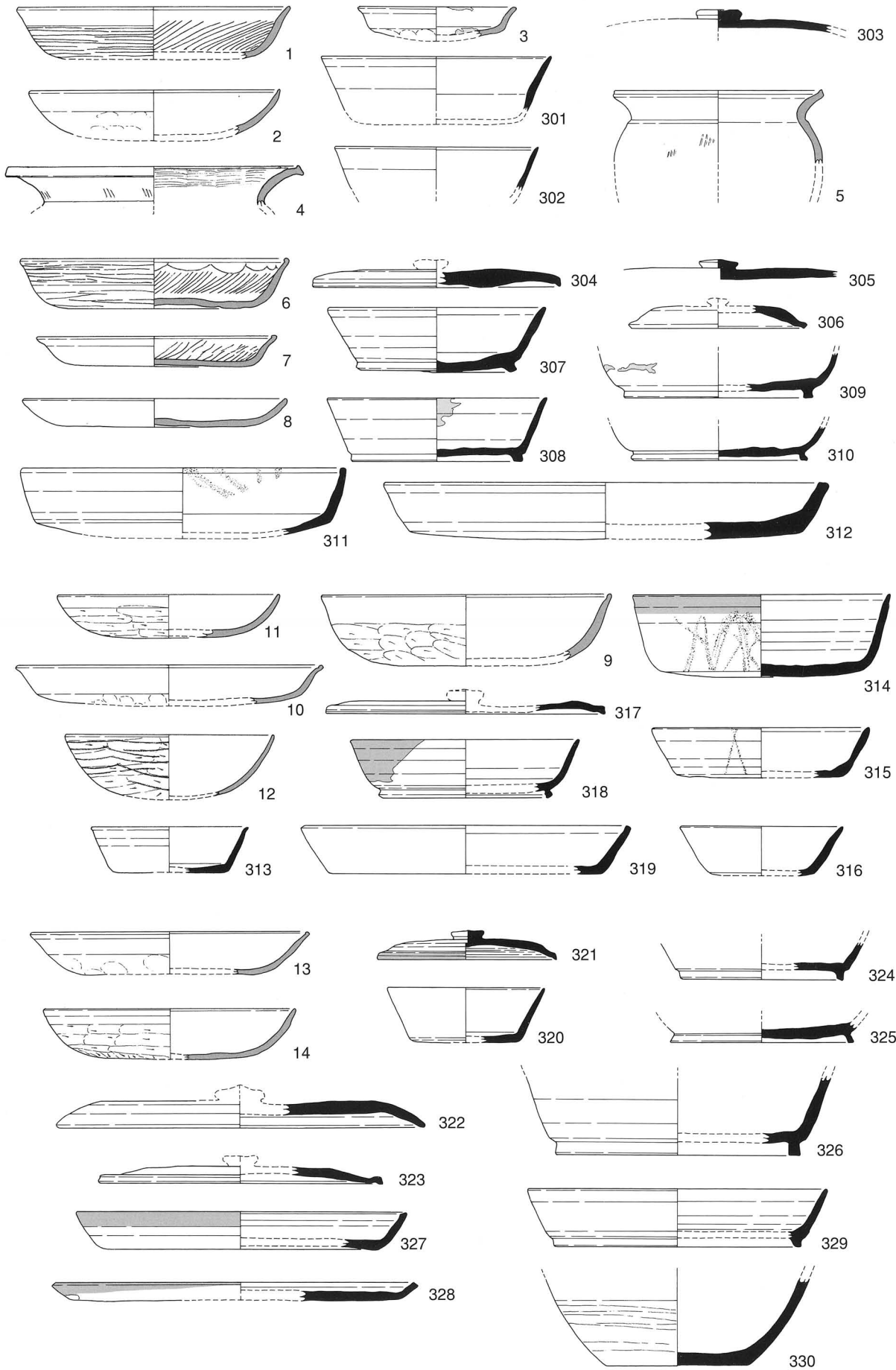

3・308は煤付着

0 20cm



6



7



13



14

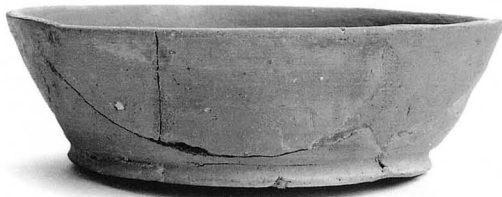

307



308



321



314



311



312

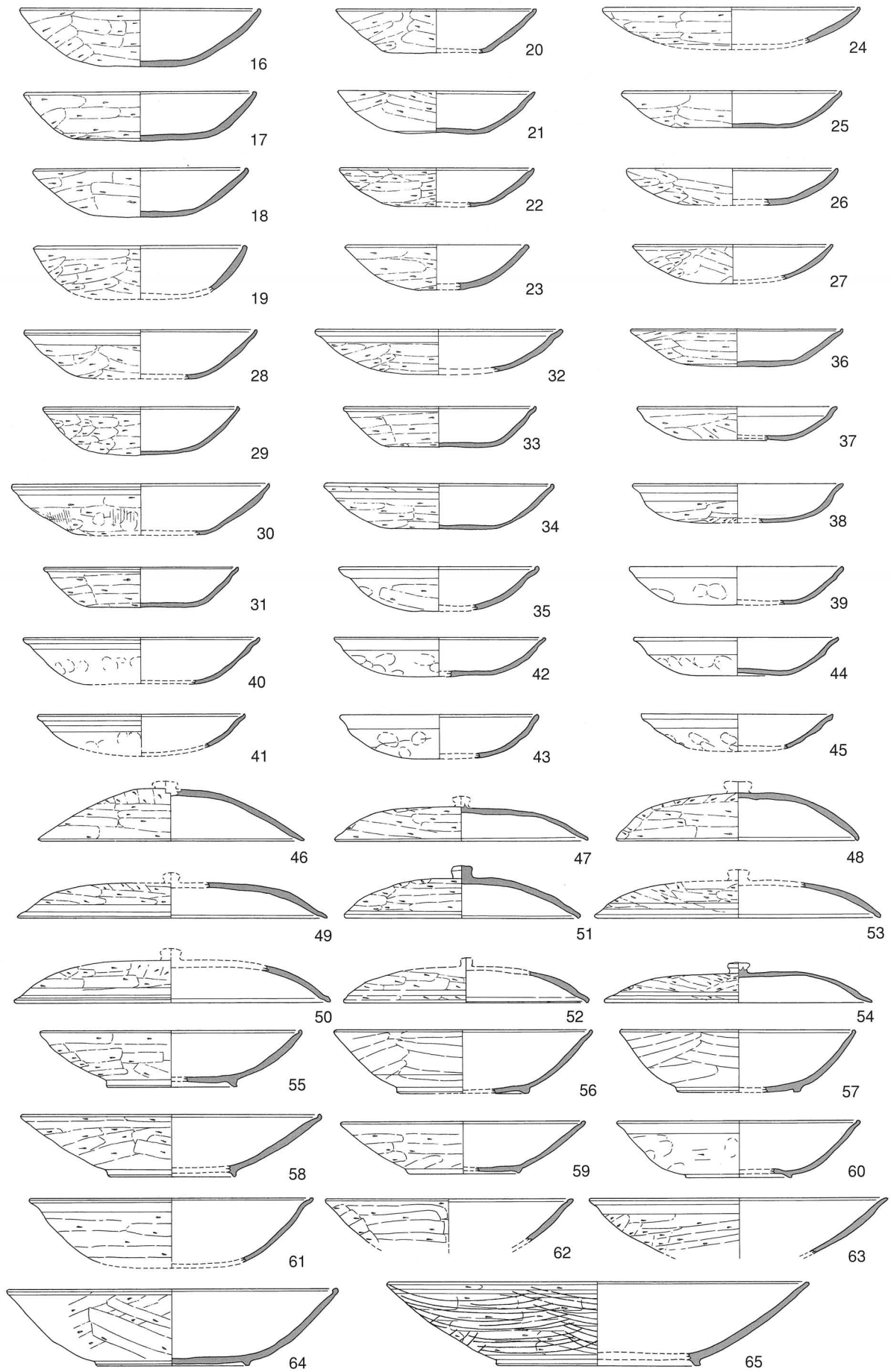

0 20cm



16



17



18



21



22



25



47



48



51

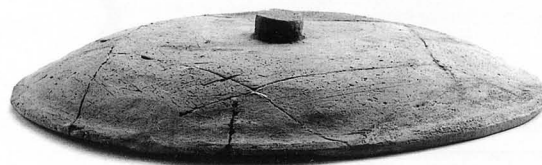

54



55



56



57



65

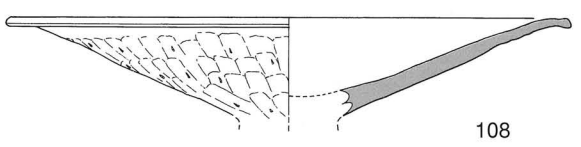
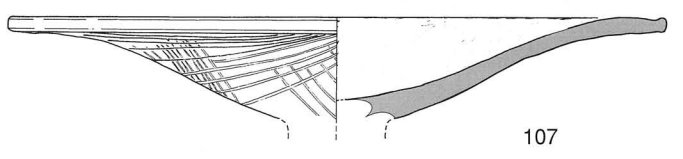
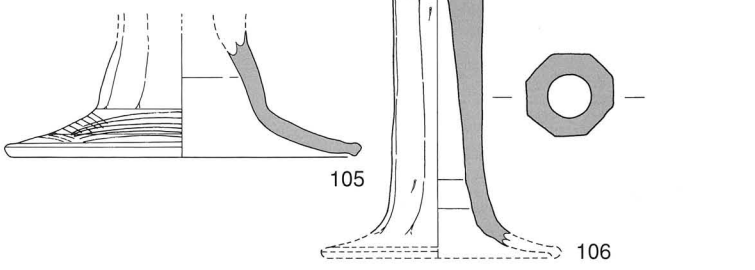
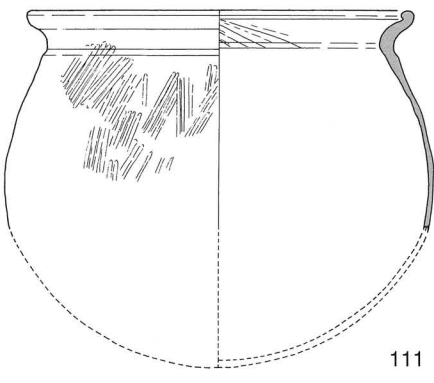
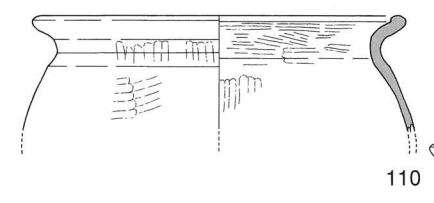
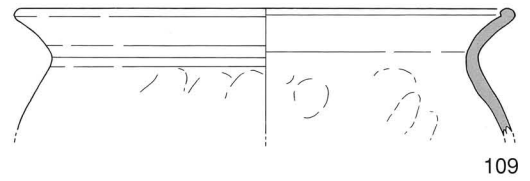
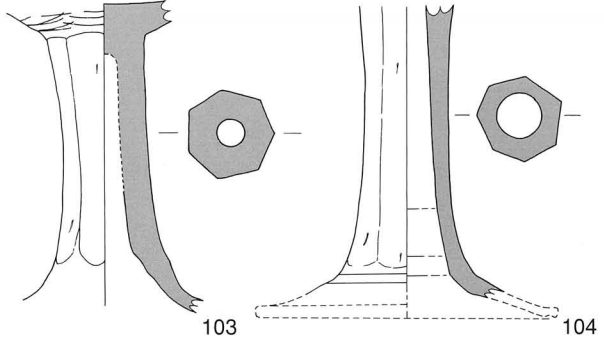
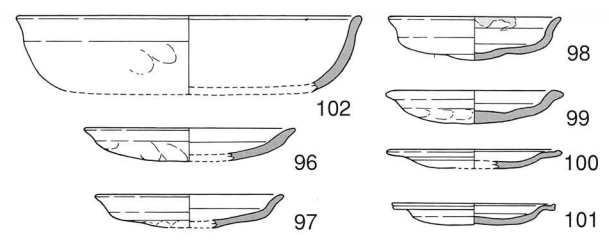
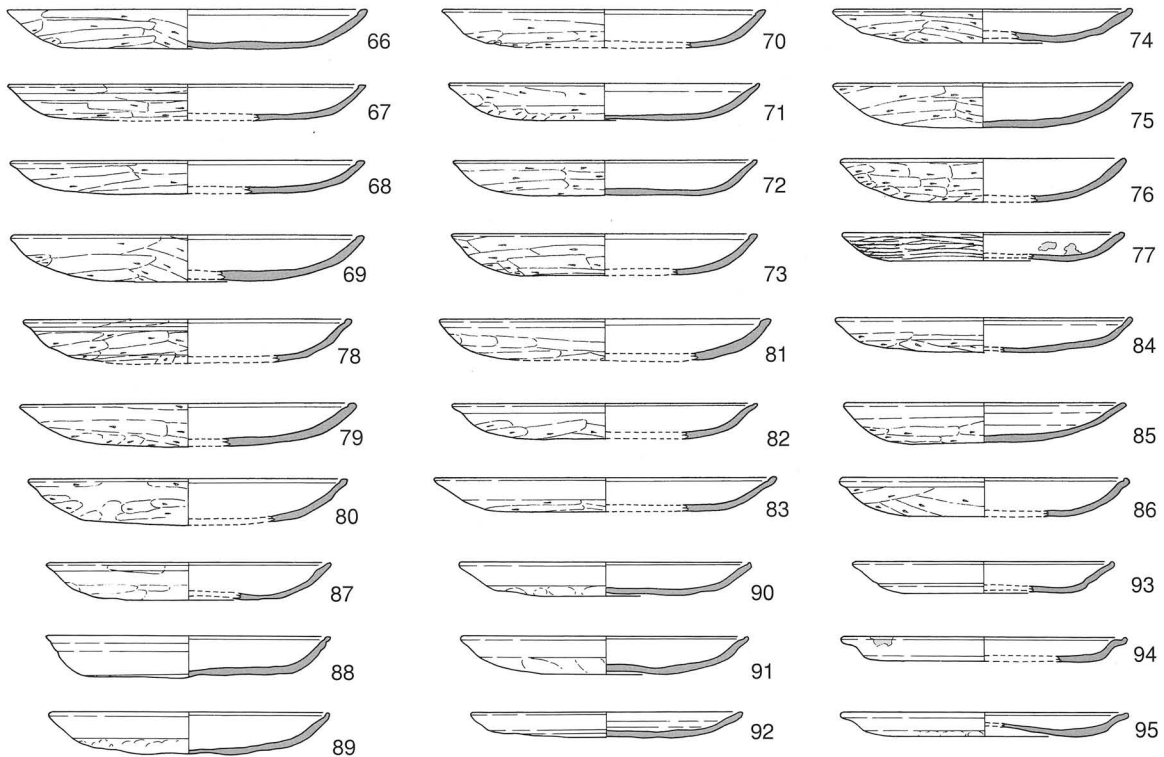

77・94・98は煤付着





66



69



72

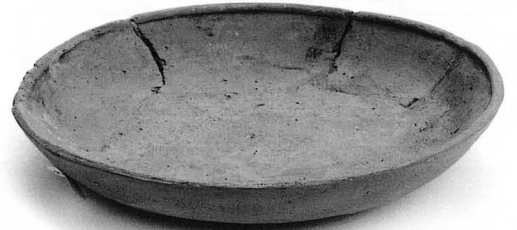

73



74



84



85



86



88



89



97



101

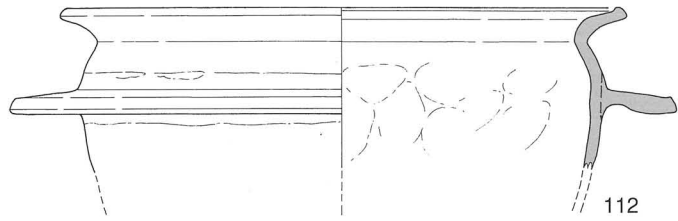

112



331

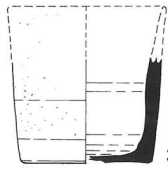
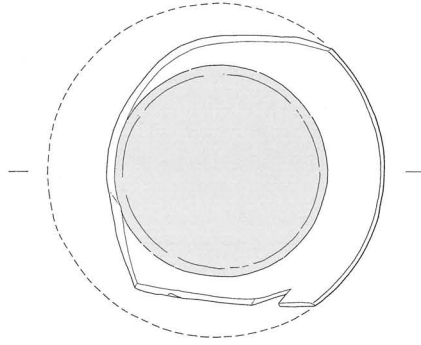

333

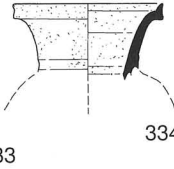

334

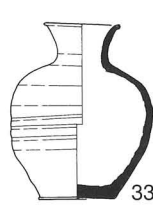

336

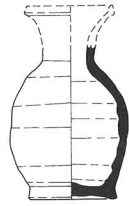

337

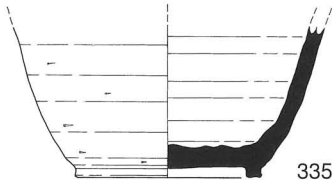

335

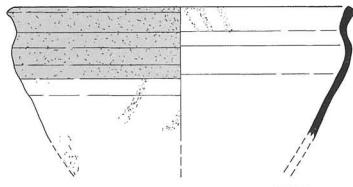

338

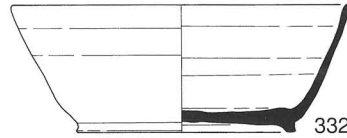

332

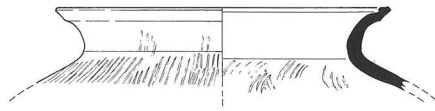

339

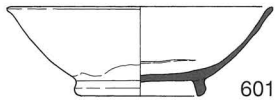

601

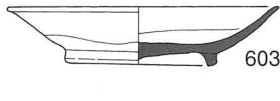

603

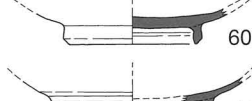

605

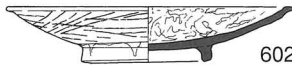

602



604



607

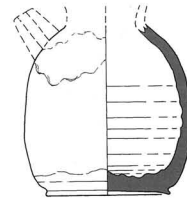

608

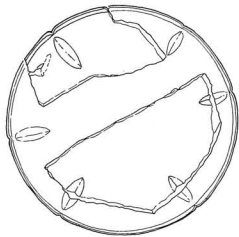

701

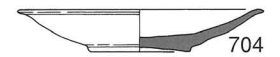

704

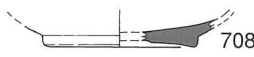

708



705



709



706



710

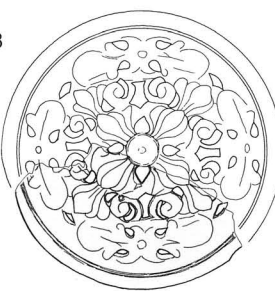

713

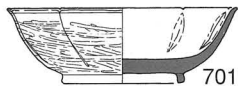

701

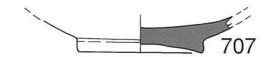

707

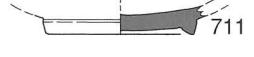

711

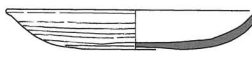

702

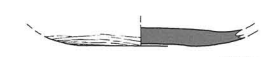

703

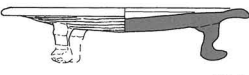

712

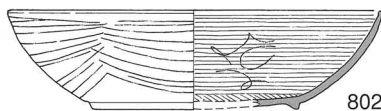

802



804

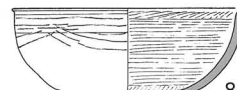

808



803



805



809



801



806

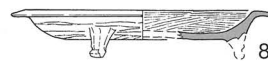

807



332は朱付着



601



332



602



608

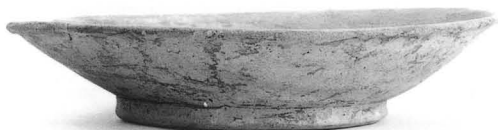

603



604



702



705

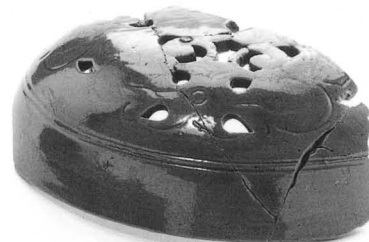

713



706



701



712



805



807

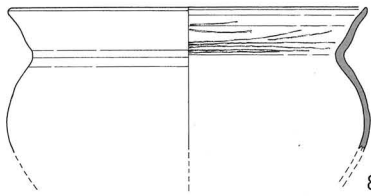

810

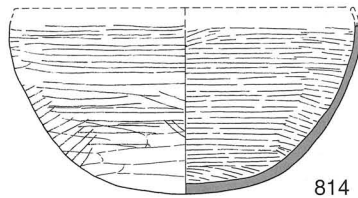

814

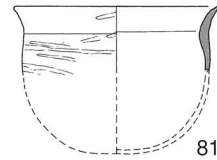

813

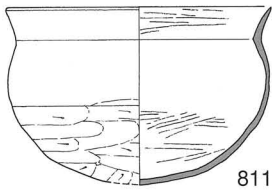

811

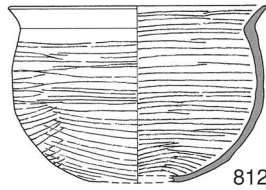

812



817

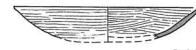

815



816



114

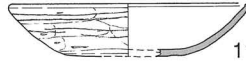

113

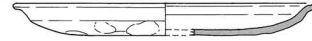

116



117

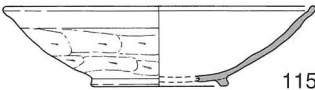

115

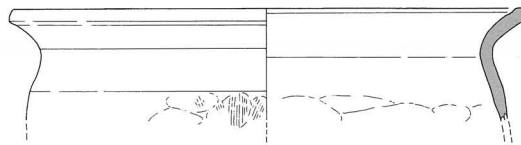

119

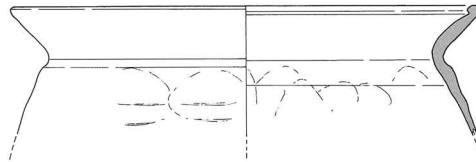

120

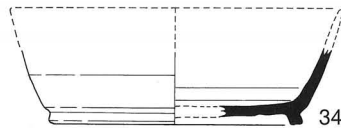

340

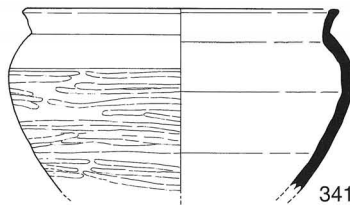

341

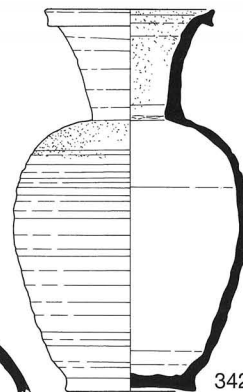

342

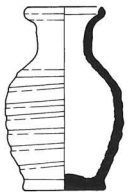

343

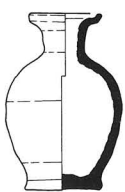

344

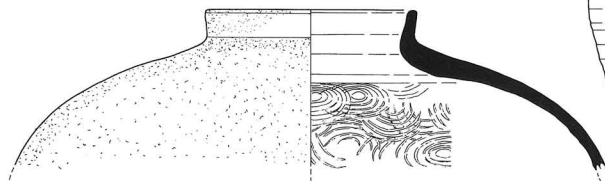

345

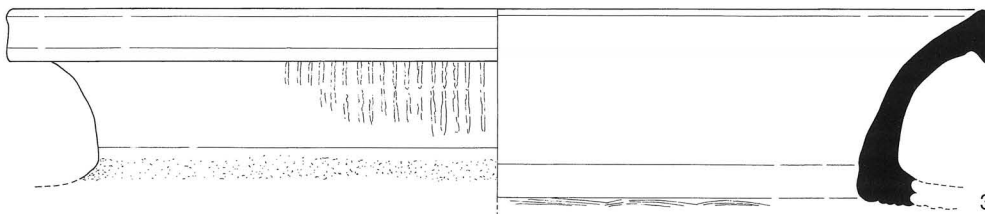

346

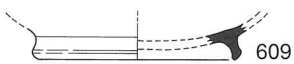

609



611



613

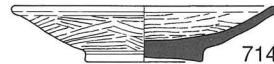

714

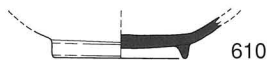

610

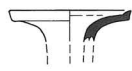

612

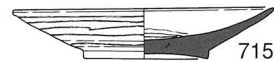

715





812



343
344



115



817



612



116



340



714

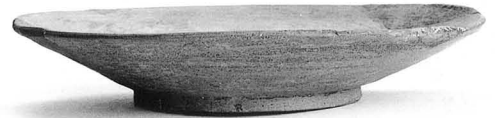

715



346

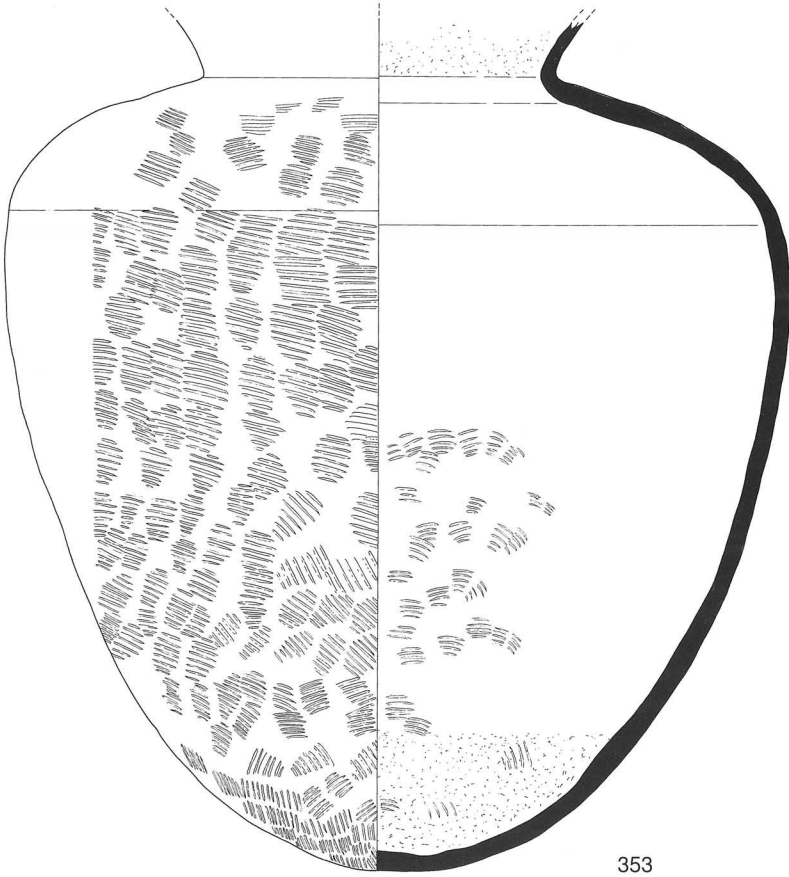
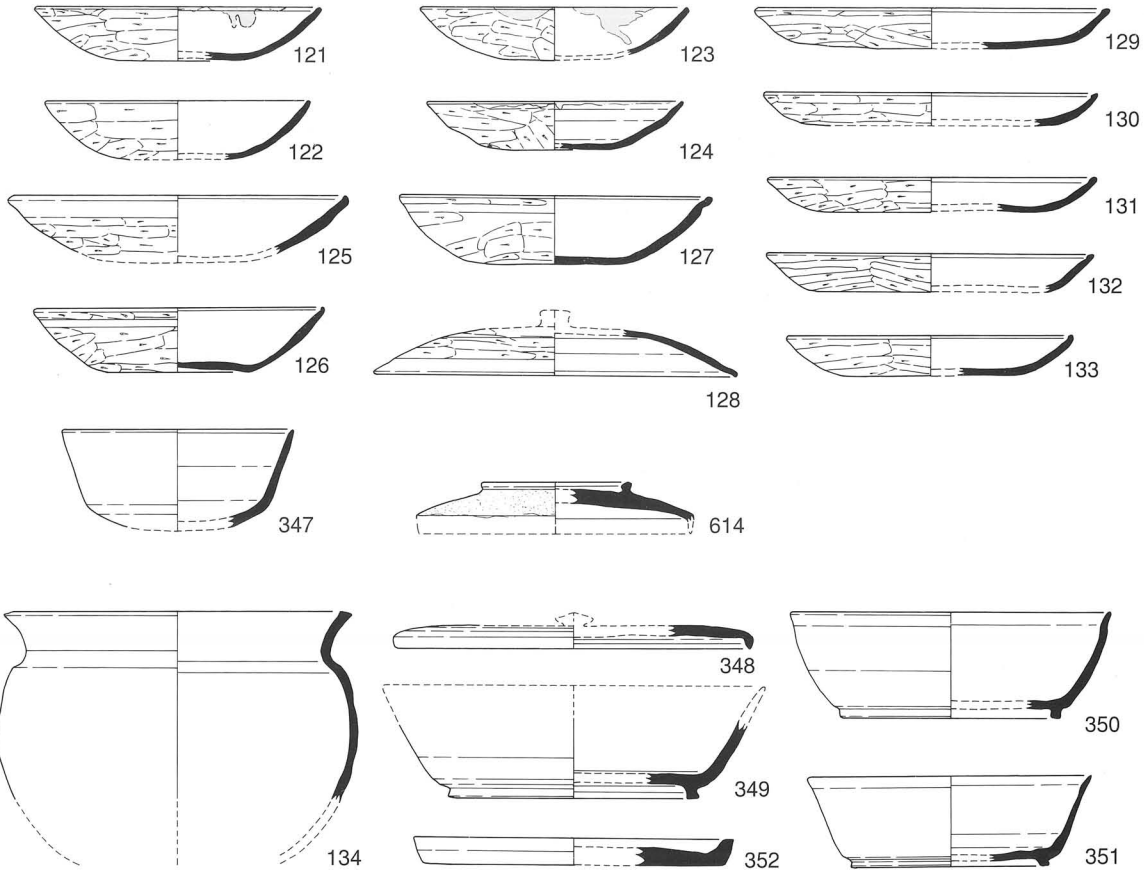

121・123・124は煤付着

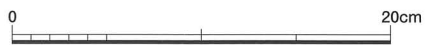



123



126



127



129



134

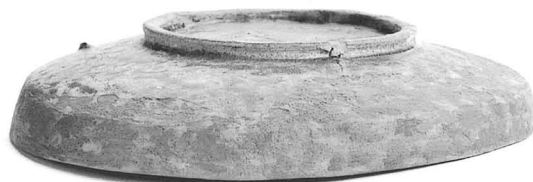

614



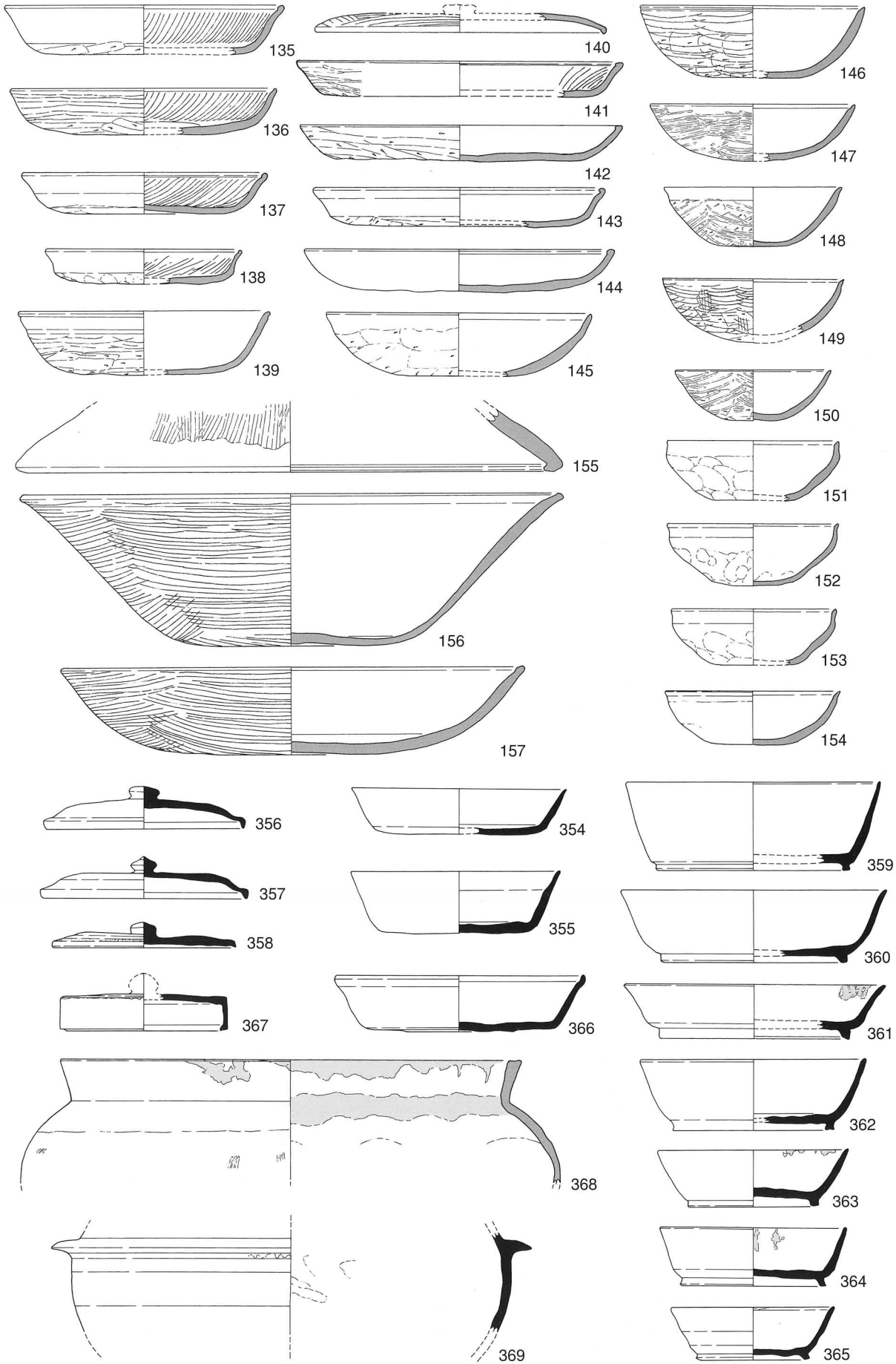

361・363・364・365・368は煤付着

0 20cm

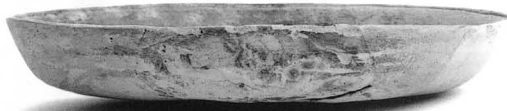

136



138



139



144



146



148



356



357



362



363



366



367



156